



**Version 1.3 0507**

*Changes for version 1.1 included the insertion of a new chapter 5 for the 2007 specification and some minor mathematical corrections in chapters 2 and 4. Please note that these are not side-barred.*

*Changes for version 1.2 include further corrections to chapter 4 and a correction to the numbering of the exercises in chapter 5.*

*Changes for version 1.3 include mathematical corrections to exercises and answers.*

**GCE Mathematics (6360)**

**Further Pure unit 2 (MFP2)**

**Textbook**

## Further Pure 2: Contents

<b>Chapter 1: Complex numbers</b>	4
1.1 Introduction	5
1.2 The general complex number	5
1.3 The modulus and argument of a complex number	6
1.4 The polar form of a complex number	8
1.5 Addition, subtraction and multiplication of complex numbers of the form $x + iy$	9
1.6 The conjugate of a complex number and the division of complex numbers of the form $x + iy$	10
1.7 Products and quotients of complex numbers in their polar form	11
1.8 Equating real and imaginary parts	13
1.9 Further consideration of $ z_2 - z_1 $ and $\arg(z_2 - z_1)$	14
1.10 Loci on Argand diagrams	15
<b>Chapter 2: Roots of polynomial equations</b>	21
2.1 Introduction	22
2.2 Quadratic equations	22
2.3 Cubic equations	24
2.4 Relationship between the roots of a cubic equation and its coefficients	27
2.5 Cubic equations with related roots	28
2.6 An important result	31
2.7 Polynomial equations of degree $n$	32
2.8 Complex roots of polynomial equations with real coefficients	33
<b>Chapter 3: Summation of finite series</b>	38
3.1 Introduction	39
3.2 Summation of series by the method of differences	40
3.3 Summation of series by the method of induction	45
3.4 Proof by induction extended to other areas of mathematics	48
<b>Chapter 4: De Moivre's theorem and its applications</b>	53
4.1 De Moivre's theorem	54
4.2 Using de Moivre's theorem to evaluate powers of complex numbers	56
4.3 Application of de Moivre's theorem in establishing trigonometric identities	60
4.4 Exponential form of a complex number	69
4.5 The cube roots of unity	71
4.6 The $n$ th roots of unity	74
4.7 The roots of $z^n = \alpha$ , where $\alpha$ is a non-real number	77

*continued overleaf*

## Further Pure 2: Contents (continued)

<b>Chapter 5: Inverse trigonometrical functions</b>	85
5.1 Introduction and revision	86
5.2 The derivatives of standard inverse trigonometrical functions	89
5.3 Application to more complex differentiation	91
5.4 Standard integrals integrating to inverse trigonometrical functions	94
5.5 Applications to more complex integrals	96
<b>Chapter 6: Hyperbolic functions</b>	102
6.1 Definitions of hyperbolic functions	103
6.2 Numerical values of hyperbolic functions	104
6.3 Graphs of hyperbolic functions	105
6.4 Hyperbolic identities	106
6.5 Osborne's rule	110
6.6 Differentiation of hyperbolic functions	111
6.7 Integration of hyperbolic functions	114
6.8 Inverse hyperbolic functions	115
6.9 Logarithmic form of inverse hyperbolic functions	116
6.10 Derivatives of inverse hyperbolic functions	119
6.11 Integrals which integrate to inverse hyperbolic functions	122
6.12 Solving equations	125
<b>Chapter 7: Arc length and area of surface of revolution</b>	131
7.1 Introduction	132
7.2 Arc length	133
7.3 Area of surface of revolution	137
<b>Answers to the exercises in Further Pure 2</b>	143

## Chapter 1: Complex Numbers

- 1.1 Introduction
- 1.2 The general complex number
- 1.3 The modulus and argument of a complex number
- 1.4 The polar form of a complex number
- 1.5 Addition, subtraction and multiplication of complex numbers of the form  $x + iy$
- 1.6 The conjugate of a complex number and the division of complex numbers of the form  $x + iy$
- 1.7 Products and quotients of complex numbers in their polar form
- 1.8 Equating real and imaginary parts
- 1.9 Further consideration of  $|z_2 - z_1|$  and  $\arg(z_2 - z_1)$
- 1.10 Loci on Argand diagrams

---

This chapter introduces the idea of a complex number. When you have completed it, you will:

- know what is meant by a complex number;
- know what is meant by the modulus and argument of a complex number;
- know how to add, subtract, multiply and divide complex numbers;
- know how to solve equations using real and imaginary parts;
- understand what an Argand diagram is;
- know how to sketch loci on Argand diagrams.

## 1.1 Introduction

You will have discovered by now that some problems cannot be solved in terms of real numbers. For example, if you use a calculator to evaluate  $\sqrt{-64}$  you get an error message. This is because squaring every real number gives a positive value; both  $(+8)^2$  and  $(-8)^2$  are equal to 64.

As  $\sqrt{-1}$  cannot be evaluated, a symbol is used to denote it – the symbol used is  $i$ .

$$\boxed{\sqrt{-1} = i \quad i^2 = -1}$$

It follows that

$$\sqrt{-64} = \sqrt{64 \times -1} = \sqrt{64} \times \sqrt{-1} = 8i.$$

## 1.2 The general complex number

The most general number that can be written down has the form  $x + iy$ , where  $x$  and  $y$  are **real** numbers. The term  $x + iy$  is a complex number with  $x$  being the **real part** and  $iy$  the **imaginary part**. So, both  $2 + 3i$  and  $-1 - 4i$  are complex numbers. The set of real numbers,  $\mathbb{R}$  (with which you are familiar), is really a subset of the set of complex numbers,  $\mathbb{C}$ . This is because real numbers are actually numbers of the form  $x + 0i$ .

### 1.3 The modulus and argument of a complex number

Just as real numbers can be represented by points on a number line, complex numbers can be represented by points in a plane. The point  $P(x, y)$  in the plane of coordinates with axes  $Ox$  and  $Oy$  represents the complex number  $x + iy$  and the number is uniquely represented by that point. The diagram of points in Cartesian coordinates representing complex numbers is called an **Argand diagram**.

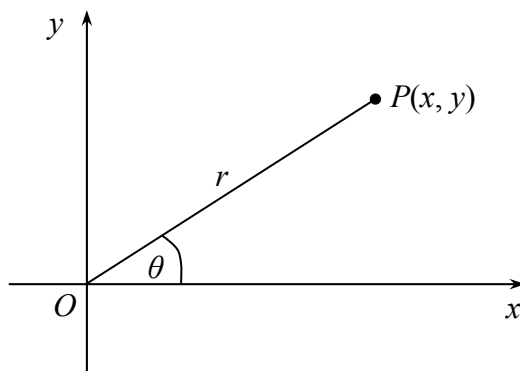

If the complex number  $x + iy$  is denoted by  $z$ , and hence  $z = x + iy$ ,  $|z|$  ('mod zed') is defined as the distance from the origin  $O$  to the point  $P$  representing  $z$ . Thus  $|z| = OP = r$ .

The modulus of a complex number  $z$  is given by  $|z| = \sqrt{x^2 + y^2}$

The argument of  $z$ ,  $\arg z$ , is defined as the angle between the line  $OP$  and the positive  $x$ -axis – usually in the range  $(\pi, -\pi)$ .

The argument of a complex number  $z$  is given by  $\arg z = \theta$ , where  $\tan \theta = \frac{y}{x}$

You must be careful when  $x$  or  $y$ , or both, are negative.

**Example 1.3.1**

Find the modulus and argument of the complex number  $-1 + \sqrt{3}i$ .

**Solution**

The point  $P$  representing this number,  $z$ , is shown on the diagram.

$$|z| = \sqrt{(-1)^2 + (\sqrt{3})^2} = 2 \quad \text{and} \quad \tan \theta = \frac{\sqrt{3}}{-1} = -\sqrt{3}.$$

Therefore,  $\arg z = \frac{2\pi}{3}$ .

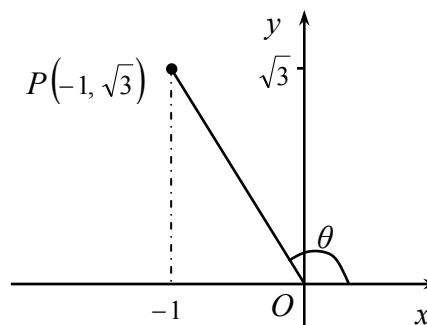

Note that when  $\tan \theta = -\sqrt{3}$ ,  $\theta$  could equal  $+\frac{2\pi}{3}$  or  $-\frac{\pi}{3}$ . However, the sketch clearly shows that  $\theta$  lies in the second quadrant. This is why you need to be careful when evaluating the argument of a complex number.

**Exercise 1A**

1. Find the modulus and argument of each of the following complex numbers:

- (a)  $1-i$ ,    (b)  $3i$ ,    (c)  $-4$ ,    (d)  $-\sqrt{3}-i$ .

Give your answers for  $\arg z$  in radians to two decimal places.

2. Find the modulus and argument of each of the following complex numbers:

- (a)  $-3+i$ ,    (b)  $3+4i$ ,    (c)  $-1-7i$ .

Give your answers for  $\arg z$  in radians to two decimal places.

### 1.4 The polar form of a complex number

In the diagram alongside,  $x = r \cos \theta$  and  $y = r \sin \theta$ .

If  $P$  is the point representing the complex number  $z = x + iy$ , it follows that  $z$  may be written in the form  $r \cos \theta + ir \sin \theta$ . This is called the **polar**, or **modulus–argument**, form of a complex number.

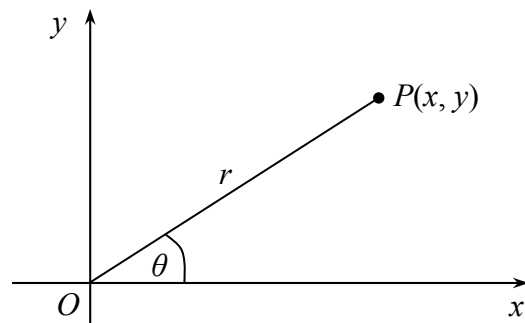

A complex number may be written in the form  $z = r(\cos \theta + i \sin \theta)$ , where  $|z| = r$  and  $\arg z = \theta$

For brevity,  $r(\cos \theta + i \sin \theta)$  can be written as  $(r, \theta)$ .

#### Exercise 1B

1. Write the complex numbers given in Exercise 1A in polar coordinate form.
2. Find, in the form  $x + iy$ , the complex numbers given in polar coordinate form by:
  - (a)  $z = 2\left(\cos \frac{3\pi}{4} + i \sin \frac{3\pi}{4}\right)$ ,
  - (b)  $4\left(\cos -\frac{2\pi}{3} + i \sin -\frac{2\pi}{3}\right)$ .



## 1.5 Addition, subtraction and multiplication of complex numbers of the form $x + iy$

Complex numbers can be subjected to arithmetic operations. Consider the example below.

### Example 1.5.1

Given that  $z_1 = 3 + 4i$  and  $z_2 = 1 - 2i$ , find (a)  $z_1 + z_2$ , (b)  $z_1 - z_2$  and (c)  $z_1 z_2$ .

#### Solution

$$\begin{aligned} \text{(a)} \quad z_1 + z_2 &= (3 + 4i) + (1 - 2i) \\ &= 4 + 2i. \end{aligned}$$

$$\begin{aligned} \text{(b)} \quad z_1 - z_2 &= (3 + 4i) - (1 - 2i) \\ &= 2 + 6i. \end{aligned}$$

$$\begin{aligned} \text{(c)} \quad z_1 z_2 &= (3 + 4i)(1 - 2i) \\ &= 3 + 4i - 6i - 8i^2 \\ &= 3 - 2i + 8 \quad (\text{since } i^2 = -1) \\ &= 11 - 2i. \end{aligned}$$

$$\begin{aligned} \text{In general, if } z_1 &= a_1 + ib_1 \text{ and } z_2 = a_2 + ib_2, \\ z_1 + z_2 &= (a_1 + a_2) + i(b_1 + b_2) \\ z_1 - z_2 &= (a_1 - a_2) + i(b_1 - b_2) \\ z_1 z_2 &= a_1 a_2 - b_1 b_2 + i(a_2 b_1 + a_1 b_2) \end{aligned}$$

### Exercise 1C

1. Find  $z_1 + z_2$  and  $z_1 z_2$  when:

(a)  $z_1 = 1 + 2i$  and  $z_2 = 2 - i$ ,

(b)  $z_1 = -2 + 6i$  and  $z_2 = 1 + 2i$ .

## 1.6 The conjugate of a complex number and the division of complex numbers of the form $x + iy$

The conjugate of a complex number  $z = x + iy$  (usually denoted by  $z^*$  or  $\bar{z}$ ) is the complex number  $z^* = x - iy$ . Thus, the conjugate of  $-3 + 2i$  is  $-3 - 2i$ , and that of  $2 - i$  is  $2 + i$ . On an Argand diagram, the point representing the complex number  $z^*$  is the reflection of the point representing  $z$  in the  $x$ -axis.

The most important property of  $z^*$  is that the product  $zz^*$  is real since

$$\begin{aligned}zz^* &= (x + iy)(x - iy) \\ &= x^2 + ixy - ixy - i^2y^2 \\ &= x^2 + y^2.\end{aligned}$$

$$zz^* = |z|^2$$

Division of two complex numbers demands a little more care than their addition or multiplication – and usually requires the use of the complex conjugate.

### Example 1.6.1

Simplify  $\frac{z_1}{z_2}$ , where  $z_1 = 3 + 4i$  and  $z_2 = 1 - 2i$ .

#### Solution

$$\begin{aligned}\frac{3 + 4i}{1 - 2i} &= \frac{(3 + 4i)(1 + 2i)}{(1 - 2i)(1 + 2i)} && \text{multiply the numerator and denominator of } \frac{z_1}{z_2} \text{ by } z_2^*, \text{ i.e. } (1 + 2i) \\ &= \frac{3 + 4i + 6i + 8i^2}{1 - 2i + 2i - 4i^2} \\ &= \frac{-5 + 10i}{5} && \text{so that the product of the denominator becomes a real number} \\ &= -1 + 2i.\end{aligned}$$

### Exercise 1D

1. For the sets of complex numbers  $z_1$  and  $z_2$ , find  $\frac{z_1}{z_2}$  where

(a)  $z_1 = 4 + 2i$  and  $z_2 = 2 - i$ ,

(b)  $z_1 = -2 + 6i$  and  $z_2 = 1 + 2i$ .

### 1.7 Products and quotients of complex numbers in their polar form

If two complex numbers are given in polar form they can be multiplied and divided without having to rewrite them in the form  $x + iy$ .

#### Example 1.7.1

Find  $z_1 z_2$  if  $z_1 = 2\left(\cos \frac{\pi}{3} + i \sin \frac{\pi}{3}\right)$  and  $z_2 = 3\left(\cos \frac{\pi}{6} - i \sin \frac{\pi}{6}\right)$ .

#### Solution

$$\begin{aligned} z_1 z_2 &= 2\left(\cos \frac{\pi}{3} + i \sin \frac{\pi}{3}\right) \times 3\left(\cos \frac{\pi}{6} - i \sin \frac{\pi}{6}\right) \\ &= 6\left(\cos \frac{\pi}{3} \cos \frac{\pi}{6} + i \sin \frac{\pi}{3} \cos \frac{\pi}{6} - i \sin \frac{\pi}{6} \cos \frac{\pi}{3} - i^2 \sin \frac{\pi}{3} \sin \frac{\pi}{6}\right) \\ &= 6\left[\cos \frac{\pi}{3} \cos \frac{\pi}{6} + \sin \frac{\pi}{3} \sin \frac{\pi}{6} + i\left(\sin \frac{\pi}{3} \cos \frac{\pi}{6} - \cos \frac{\pi}{3} \sin \frac{\pi}{6}\right)\right] \\ &= 6\left[\cos\left(\frac{\pi}{3} - \frac{\pi}{6}\right) + i \sin\left(\frac{\pi}{3} - \frac{\pi}{6}\right)\right] \\ &= 6\left(\cos \frac{\pi}{6} + i \sin \frac{\pi}{6}\right). \end{aligned}$$

Using the identities:

$$\cos(A - B) \equiv \cos A \cos B + \sin A \sin B$$

$$\sin(A - B) \equiv \sin A \cos B - \cos A \sin B$$

Noting that  $\arg z_2$  is  $-\frac{\pi}{6}$ , it follows that the modulus of  $z_1 z_2$  is the product of the modulus of  $z_1$  and the modulus of  $z_2$ , and the argument of  $z_1 z_2$  is the sum of the arguments of  $z_1$  and  $z_2$ .

#### Exercise 1E

1. (a) Find  $\frac{z_1}{z_2}$  if  $z_1 = 2\left(\cos \frac{\pi}{3} + i \sin \frac{\pi}{3}\right)$  and  $z_2 = 3\left(\cos \frac{\pi}{6} - i \sin \frac{\pi}{6}\right)$ .

(b) What can you say about the modulus and argument of  $\frac{z_1}{z_2}$ ?

**Example 1.7.2**

If  $z_1 = (r_1, \theta_1)$  and  $z_2 = (r_2, \theta_2)$ , show that  $z_1 z_2 = r_1 r_2 [\cos(\theta_1 + \theta_2) + i \sin(\theta_1 + \theta_2)]$ .

**Solution**

$$\begin{aligned} z_1 z_2 &= r_1(\cos \theta_1 + i \sin \theta_1) r_2(\cos \theta_2 + i \sin \theta_2) \\ &= r_1 r_2 [\cos \theta_1 \cos \theta_2 + i(\sin \theta_1 \cos \theta_2 + \cos \theta_1 \sin \theta_2) + i^2 \sin \theta_1 \sin \theta_2] \\ &= r_1 r_2 [(\cos \theta_1 \cos \theta_2 - \sin \theta_1 \sin \theta_2) + i(\sin \theta_1 \cos \theta_2 + \cos \theta_1 \sin \theta_2)] \\ &= r_1 r_2 [\cos(\theta_1 + \theta_2) + i \sin(\theta_1 + \theta_2)]. \end{aligned}$$

If  $z_1 = (r_1, \theta_1)$  and  $z_2 = (r_2, \theta_2)$  then  $z_1 z_2 = (r_1 r_2, \theta_1 + \theta_2)$  – with the proviso that  $2\pi$  may have to be added to, or subtracted from,  $\theta_1 + \theta_2$  if  $\theta_1 + \theta_2$  is outside the permitted range for  $\theta$

There is a corresponding result for division – you could try to prove it for yourself.

If  $z_1 = (r_1, \theta_1)$  and  $z_2 = (r_2, \theta_2)$  then  $\frac{z_1}{z_2} = \left(\frac{r_1}{r_2}, \theta_1 - \theta_2\right)$  – with the same proviso regarding the size of the angle  $\theta_1 - \theta_2$

## 1.8 Equating real and imaginary parts

Going back to Example 1.6.1,  $\frac{z_1}{z_2}$  can be simplified by another method.

Suppose we let  $a + ib = \frac{3 + 4i}{1 - 2i}$ . Then,

$$(1 - 2i)(a + ib) = 3 + 4i$$

$$\Rightarrow a + 2b + i(b - 2a) = 3 + 4i.$$

Now,  $a$  and  $b$  are real and the complex number on the left hand side of the equation is equal to the complex number on the right hand side, so the real parts can be equated and the imaginary parts can also be equated:

$$a + 2b = 3$$

$$\text{and } b - 2a = 4.$$

Thus  $b = 2$  and  $a = -1$ , giving  $-1 + 2i$  as the answer to  $a + ib$  as in Example 1.6.1.

While this method is not as straightforward as the method used earlier, it is still a valid method. It also illustrates the concept of equating real and imaginary parts.

If  $a + ib = c + id$ , where  $a, b, c$  and  $d$  are real, then  $a = c$  and  $b = d$

### Example 1.8.1

Find the complex number  $z$  satisfying the equation

$$(3 - 4i)z - (1 + i)z^* = 13 + 2i.$$

#### Solution

Let  $z = (a + ib)$ , then  $z^* = (a - ib)$ .

Thus,  $(3 - 4i)(a + ib) - (1 + i)(a - ib) = 13 + 2i$ .

Multiplying out,  $3a - 4ia + 3ib - 4i^2b - a - ia + ib + i^2b = 13 + 2i$ .

Simplifying,  $2a + 3b + i(-5a + 4b) = 13 + 2i$ .

Equating real and imaginary parts,

$$2a + 3b = 13,$$

$$-5a + 4b = 2.$$

So,  $a = 2$  and  $b = 3$ . Hence,  $z = 2 + 3i$ .

### Exercise 1F

1. If  $z_1 = \left(3, \frac{2\pi}{3}\right)$  and  $z_2 = \left(2, -\frac{\pi}{6}\right)$ , find, in polar form, the complex numbers

(a)  $z_1 z_2$ , (b)  $\frac{z_1}{z_2}$ , (c)  $z_1^2$ , (d)  $z_1^3$ , (e)  $\frac{z_2}{z_1^2}$ .

2. Find the complex number satisfying each of these equations:

(a)  $(1 + i)z = 2 + 3i$ , (b)  $(z - i)(3 + i) = 7i + 11$ , (c)  $z + i = 2z^* - 1$ .

### 1.9 Further consideration of $|z_2 - z_1|$ and $\arg(z_2 - z_1)$

Section 1.5 considered simple cases of the sums and differences of complex numbers. Consider now the complex number  $z = z_2 - z_1$ , where  $z_1 = x_1 + iy_1$  and  $z_2 = x_2 + iy_2$ . The points  $A$  and  $B$  represent  $z_1$  and  $z_2$ , respectively, on an Argand diagram.

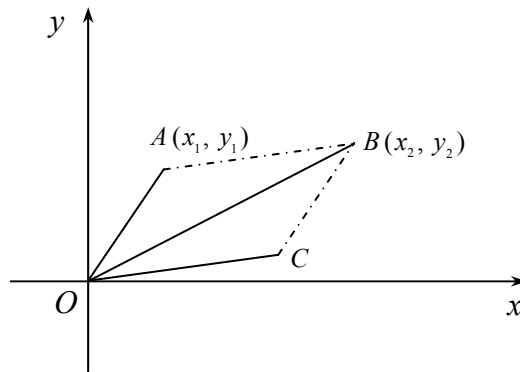

Then  $z = z_2 - z_1 = (x_2 - x_1) + i(y_2 - y_1)$  and is represented by the point  $C(x_2 - x_1, y_2 - y_1)$ . This makes  $OACB$  a parallelogram. From this it follows that

$$|z_2 - z_1| = OC = \left[ (x_2 - x_1)^2 + (y_2 - y_1)^2 \right]^{\frac{1}{2}},$$

that is to say  $|z_2 - z_1|$  is the length  $AB$  in the Argand diagram. Similarly  $\arg(z_2 - z_1)$  is the angle between  $OC$  and the positive direction of the  $x$ -axis. This in turn is the angle between  $AB$  and the positive  $x$  direction.

If the complex number  $z_1$  is represented by the point  $A$ , and the complex number  $z_2$  is represented by the point  $B$  in an Argand diagram, then

$|z_2 - z_1| = AB$ , and  $\arg(z_2 - z_1)$  is the angle between  $\overrightarrow{AB}$  and the positive direction of the  $x$ -axis

#### Exercise 1G

1. Find  $|z_2 - z_1|$  and  $\arg(z_2 - z_1)$  in

- (a)  $z_1 = 2 + 3i$ ,  $z_2 = 7 + 5i$ ,
- (b)  $z_1 = 1 - 3i$ ,  $z_2 = 4 + i$ ,
- (c)  $z_1 = -1 + 2i$ ,  $z_2 = -4 - 5i$ .

### 1.10 Loci on Argand diagrams

A locus is a path traced out by a point subjected to certain restrictions. Paths can be traced out by points representing variable complex numbers on an Argand diagram just as they can in other coordinate systems.

Consider the simplest case first, when the point  $P$  represents the complex number  $z$  such that  $|z| = k$ . This means that the distance of  $P$  from the origin  $O$  is constant and so  $P$  will trace out a circle.

$$|z| = k \text{ represents a circle with centre } O \text{ and radius } k$$

If instead  $|z - z_1| = k$ , where  $z_1$  is a fixed complex number represented by the point  $A$  on an Argand diagram, then (from Section 1.9)  $|z - z_1|$  represents the distance  $AP$  and is constant. It follows that  $P$  must lie on a circle with centre  $A$  and radius  $k$ .

$$|z - z_1| = k \text{ represents a circle with centre } z_1 \text{ and radius } k$$

Note that if  $|z - z_1| \leq k$ , then the point  $P$  representing  $z$  can not only lie on the circumference of the circle, but also anywhere inside the circle. The locus of  $P$  is therefore the region on and within the circle with centre  $A$  and radius  $k$ .

Now consider the locus of a point  $P$  represented by the complex number  $z$  subject to the conditions  $|z - z_1| = |z - z_2|$ , where  $z_1$  and  $z_2$  are fixed complex numbers represented by the points  $A$  and  $B$  on an Argand diagram. Again, using the result of Section 1.9, it follows that  $AP = BP$  because  $|z - z_1|$  is the distance  $AP$  and  $|z - z_2|$  is the distance  $BP$ . Hence, the locus of  $P$  is a straight line.

$$|z - z_1| = |z - z_2| \text{ represents a straight line – the perpendicular bisector of the line joining the points } z_1 \text{ and } z_2$$

Note also that if  $|z - z_1| \leq |z - z_2|$  the locus of  $z$  is not only the perpendicular bisector of  $AB$ , but also the whole half plane, in which  $A$  lies, bounded by this bisector.

All the loci considered so far have been related to distances – there are also simple loci in Argand diagrams involving angles.

The simplest case is the locus of  $P$  subject to the condition that  $\arg z = \alpha$ , where  $\alpha$  is a fixed angle.

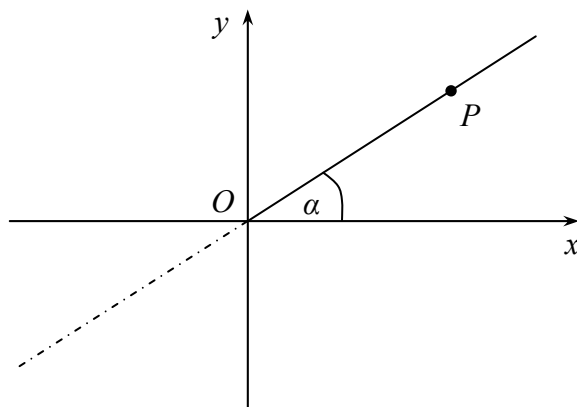

This condition implies that the angle between  $OP$  and  $Ox$  is fixed ( $\alpha$ ) so that the locus of  $P$  is a straight line.

$\arg z = \alpha$  represents the *half* line through  $O$  inclined at an angle  $\alpha$  to the positive direction of  $Ox$

Note that the locus of  $P$  is only a half line – the other half line, shown dotted in the diagram above, would have the equation  $\arg z = \pi + \alpha$ , possibly  $\pm 2\pi$  if  $\pi + \alpha$  falls outside the specified range for  $\arg z$ .

In exactly the same way as before, the locus of a point  $P$  satisfying  $\arg(z - z_1) = \alpha$ , where  $z_1$  is a fixed complex number represented by the point  $A$ , is a line through  $A$ .

$\arg(z - z_1) = \alpha$  represents the *half* line through *the point*  $z_1$  inclined at an angle  $\alpha$  to the positive direction of  $Ox$

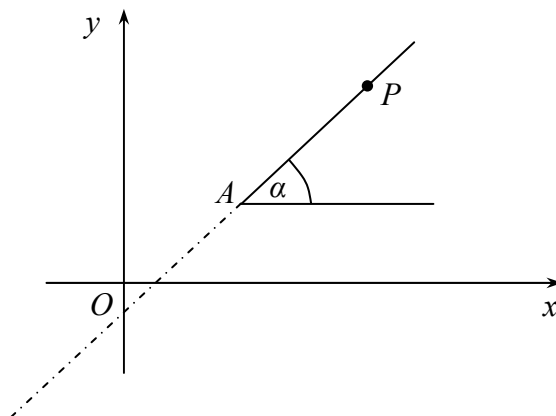

Note again that this locus is only a half line – the other half line would have the equation  $\arg(z - z_1) = \pi + \alpha$ , possibly  $\pm 2\pi$ .

Finally, consider the locus of any point  $P$  satisfying  $\alpha \leq \arg(z - z_1) \leq \beta$ . This indicates that the angle between  $AP$  and the positive  $x$ -axis lies between  $\alpha$  and  $\beta$ , so that  $P$  can lie on or within the two half lines as shown shaded in the diagram below.

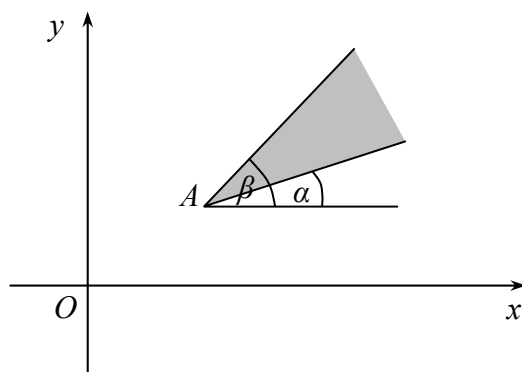



**Exercise 1H**

1. Sketch on Argand diagrams the locus of points satisfying:

(a)  $|z| = 3$ , (b)  $\arg(z-1) = \frac{\pi}{4}$ , (c)  $|z-2-i| = 5$ .

2. Sketch on Argand diagrams the regions where:

(a)  $|z-3i| \leq 3$ , (b)  $\frac{\pi}{2} \leq \arg(z-4-2i) \leq \frac{5\pi}{6}$ .

3. Sketch on an Argand diagram the region satisfying both  $|z-1-i| \leq 3$  and  $0 \leq \arg z \leq \frac{\pi}{4}$ .

4. Sketch on an Argand diagram the locus of points satisfying both  $|z-i| = |z+1+2i|$  and  $|z+3i| \leq 4$ .

**Miscellaneous exercises 1**

1. Find the complex number which satisfies the equation

$$2z + iz^* = 4 - i,$$

where  $z^*$  denotes the complex conjugate of  $z$ .

[AQA June 2001]

2. The complex number  $z$  satisfies the equation

$$3(z-1) = i(z+1).$$

(a) Find  $z$  in the form  $a + ib$ , where  $a$  and  $b$  are real.

(b) Mark and label on an Argand diagram the points representing  $z$  and its conjugate,  $z^*$ .

(c) Find the values of  $|z|$  and  $|z - z^*|$ .

[NEAB March 1998]

3. The complex number  $z$  satisfies the equation

$$zz^* - 3z - 2z^* = 2i,$$

where  $z^*$  denotes the complex conjugate of  $z$ . Find the two possible values of  $z$ , giving your answers in the form  $a + ib$ .

[AQA March 2000]

4. By putting  $z = x + iy$ , find the complex number  $z$  which satisfies the equation

$$z + 2z^* = \frac{1+i}{2+i},$$

where  $z^*$  denotes the complex conjugate of  $z$ .

[AQA Specimen]

5. (a) Sketch on an Argand diagram the circle  $C$  whose equation is

$$|z - \sqrt{3} - i| = 1.$$

(b) Mark the point  $P$  on  $C$  at which  $|z|$  is a minimum. Find this minimum value.

(c) Mark the point  $Q$  on  $C$  at which  $\arg z$  is a maximum. Find this maximum value.

[NEAB June 1998]

6. (a) Sketch on a common Argand diagram
- (i) the locus of points for which  $|z - 2 - 3i| = 3$ ,
  - (ii) the locus of points for which  $\arg z = \frac{1}{4}\pi$ .

- (b) Indicate, by shading, the region for which
- $$|z - 2 - 3i| < 3 \text{ and } \arg z < \frac{1}{4}\pi.$$

[AQA June 2001]

7. The complex number  $z$  is defined by

$$z = \frac{1 + 3i}{1 - 2i}.$$

- (a) (i) Express  $z$  in the form  $a + ib$ .
- (ii) Find the modulus and argument of  $z$ , giving your answer for the argument in the form  $p\pi$  where  $-1 < p \leq 1$ .
- (b) The complex number  $z_1$  has modulus  $2\sqrt{2}$  and argument  $-\frac{7\pi}{12}$ . The complex number  $z_2$  is defined by  $z_2 = z z_1$ .
- (i) Show that  $|z_2| = 4$  and  $\arg z_2 = \frac{\pi}{6}$ .
  - (ii) Mark on an Argand diagram the points  $P_1$  and  $P_2$  which represent  $z_1$  and  $z_2$ , respectively.
  - (iii) Find, in surd form, the distance between  $P_1$  and  $P_2$ .

[AQA June 2000]

8. (a) Indicate on an Argand diagram the region of the complex plane in which

$$0 \leq \arg(z+1) \leq \frac{2\pi}{3}.$$

(b) The complex number  $z$  is such that

$$0 \leq \arg(z+1) \leq \frac{2\pi}{3}$$

and 
$$\frac{\pi}{6} \leq \arg(z+3) \leq \pi.$$

(i) Sketch another Argand diagram showing the region  $R$  in which  $z$  must lie.

(ii) Mark on this diagram the point  $A$  belonging to  $R$  at which  $|z|$  has its least possible value.

(c) At the point  $A$  defined in part (b)(ii),  $z = z_A$ .

(i) Calculate the value of  $|z_A|$ .

(ii) Express  $z_A$  in the form  $a + ib$ .

[AQA March 1999]

9. (a) The complex numbers  $z$  and  $w$  are such that

$$z = (4 + 2i)(3 - i)$$

and

$$w = \frac{4 + 2i}{3 - i}.$$

Express each of  $z$  and  $w$  in the form  $a + ib$ , where  $a$  and  $b$  are real.

(b) (i) Write down the modulus and argument of each of the complex numbers  $4 + 2i$  and  $3 - i$ . Give each modulus in an exact surd form and each argument in radians between  $-\pi$  and  $\pi$ .

(ii) The points  $O$ ,  $P$  and  $Q$  in the complex plane represent the complex numbers  $0 + 0i$ ,  $4 + 2i$  and  $3 - i$ , respectively. Find the exact length of  $PQ$  and hence, or otherwise, show that the triangle  $OPQ$  is right-angled.

[AEB June 1997]

## Chapter 2: Roots of Polynomial Equations

- 2.1 Introduction
  - 2.2 Quadratic equations
  - 2.3 Cubic equations
  - 2.4 Relationship between the roots of a cubic equation and its coefficients
  - 2.5 Cubic equations with related roots
  - 2.6 An important result
  - 2.7 Polynomial equations of degree  $n$
  - 2.8 Complex roots of polynomial equations with real coefficients
- 
- 

This chapter revises work already covered on roots of equations and extends those ideas. When you have completed it, you will:

- know how to solve **any** quadratic equation;
- know that there is a relationship between the number of real roots and form of a polynomial equation, and be able to sketch graphs;
- know the relationship between the roots of a cubic equation and its coefficients;
- be able to form cubic equations with related roots;
- know how to extend these results to polynomials of higher degree;
- know that complex conjugates are roots of polynomials with real coefficients.

## 2.1 Introduction

You should have already met the idea of a polynomial equation. A polynomial equation of degree 2, one with  $x^2$  as the highest power of  $x$ , is called a quadratic equation. Similarly, a polynomial equation of degree 3 has  $x^3$  as the highest power of  $x$  and is called a cubic equation; one with  $x^4$  as the highest power of  $x$  is called a quartic equation. In this chapter you are going to study the properties of the roots of these equations and investigate methods of solving them.

## 2.2 Quadratic equations

You should be familiar with quadratic equations and their properties from your earlier studies of pure mathematics. However, even if this section is familiar to you it provides a suitable base from which to move on to equations of higher degree.

You will know, for example, that quadratic equations of the type you have met have two roots (which may be coincident). There are normally two ways of solving a quadratic equation – by factorizing and, in cases where this is impossible, by the quadratic formula.

Graphically, the roots of the equation  $ax^2 + bx + c = 0$  are the points of intersection of the curve  $y = ax^2 + bx + c$  and the line  $y = 0$  (i.e. the  $x$ -axis). For example, a sketch of part of  $y = x^2 + 2x - 8$  is shown below.

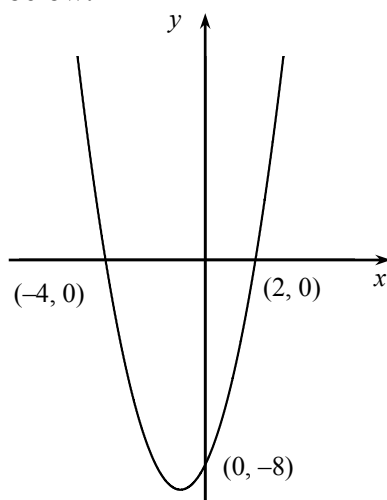

The roots of this quadratic equation are those of  $(x - 2)(x + 4) = 0$ , which are  $x = 2$  and  $-4$ .

A sketch of part of the curve  $y = x^2 - 4x + 4$  is shown below.

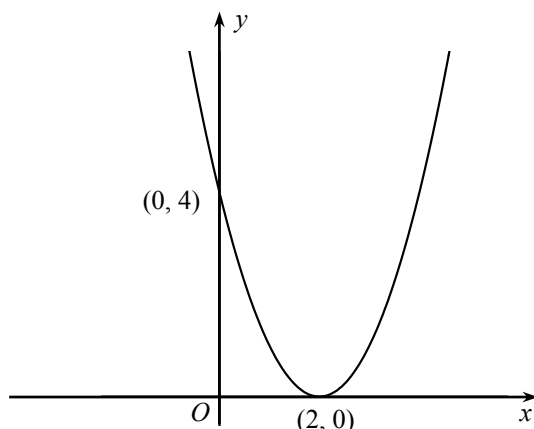

In this case, the curve touches the  $x$ -axis. The equation  $x^2 - 4x + 4 = 0$  may be written as  $(x - 2)^2 = 0$  and  $x = 2$ , a repeated root.

Not all quadratic equations are as straightforward as the ones considered so far. A sketch of part of the curve  $y = x^2 - 4x + 5$  is shown below.

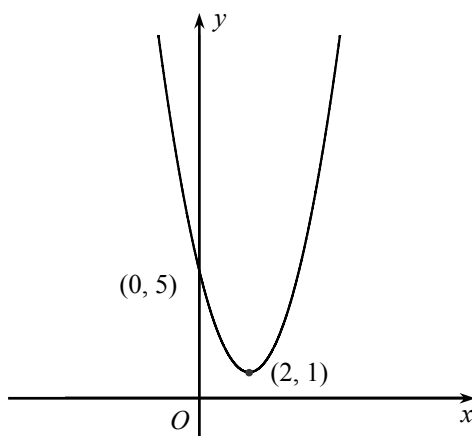

This curve does not touch the  $x$ -axis so the equation  $x^2 - 4x + 5 = 0$  cannot have real roots.

Certainly,  $x^2 - 4x + 5$  will not factorize so the quadratic formula  $\left(x = \frac{-b \pm \sqrt{b^2 - 4ac}}{2a}\right)$  has to

be used to solve this equation. This leads to  $x = \frac{4 \pm \sqrt{16 - 20}}{2}$  and, using ideas from

Chapter 1, this becomes  $\frac{4 \pm 2i}{2}$  or  $2 \pm i$ . It follows that the equation  $x^2 - 4x + 5 = 0$  does have two roots, but they are both complex numbers. In fact the two roots are complex conjugates. You may also have observed that whether a quadratic equation has real or complex roots depends on the value of the discriminant  $b^2 - 4ac$ .

The quadratic equation  $ax^2 + bx + c = 0$ , where  $a$ ,  $b$  and  $c$  are real, has complex roots if  $b^2 - 4ac < 0$

**Exercise 2A**

1. Solve the equations

(a)  $x^2 + 6x + 10 = 0$ ,      (b)  $x^2 + 10x + 26 = 0$ .

**2.3 Cubic equations**

As mentioned in the introduction to this chapter, equations of the form  $ax^3 + bx^2 + cx + d = 0$  are called cubic equations. All cubic equations have at least one real root – and this real root is not always easy to locate. The reason for this is that cubic curves are continuous – they do not have asymptotes or any other form of discontinuity. Also, as  $x \rightarrow \infty$ , the term  $ax^3$  becomes the dominant part of the expression and  $ax^3 \rightarrow \infty$  (if  $a > 0$ ), whilst  $ax^3 \rightarrow -\infty$  when  $x \rightarrow -\infty$ . Hence the curve must cross the line  $y = 0$  at least once. If  $a < 0$ , then  $ax^3 \rightarrow -\infty$  as  $x \rightarrow \infty$ , and  $ax^3 \rightarrow \infty$  as  $x \rightarrow -\infty$  and this does not affect the result.



A typical cubic equation,  $y = ax^3 + bx^2 + cx + d$  with  $a > 0$ , can look like any of the sketches below.

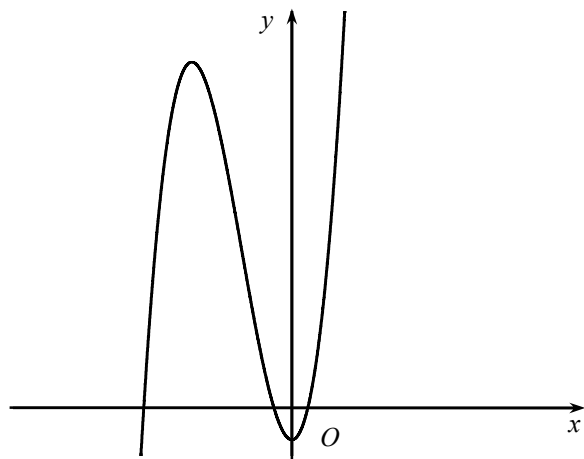

The equation of this curve has three real roots because the curve crosses the line  $y = 0$  at three points.

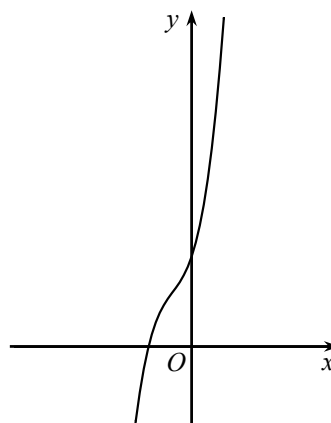
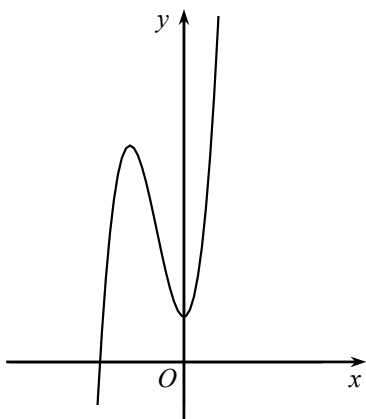

In each of the two sketch graphs above, the curve crosses the line  $y = 0$  just once, indicating just one real root. In both cases, the cubic equation will have two complex roots as well as the single real root.

### Example 2.3.1

- (a) Find the roots of the cubic equation  $x^3 + 3x^2 - x - 3 = 0$ .  
 (b) Sketch a graph of  $y = x^3 + 3x^2 - x - 3$ .

#### Solution

- (a) If  $f(x) = x^3 + 3x^2 - x - 3$ ,  
 then  $f(1) = 1 + 3 - 1 - 3 = 0$ .  
 Therefore  $x - 1$  is a factor of  $f(x)$ .  
 $\therefore f(x) = (x - 1)(x^2 + 4x + 3)$   
 $= (x - 1)(x + 3)(x + 1)$ .  
 Hence the roots of  $f(x) = 0$  are 1, -3 and -1.

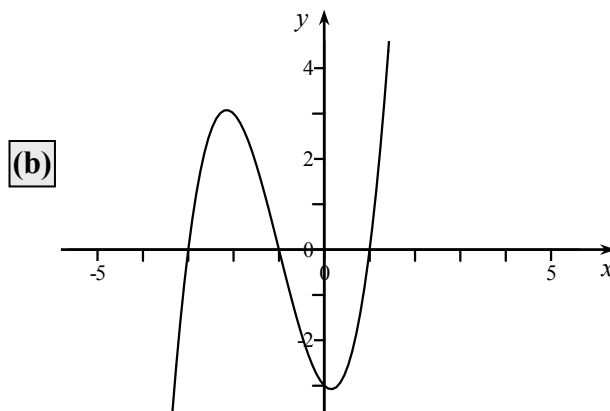

**Example 2.3.2**

Find the roots of the cubic equation  $x^3 + 4x^2 + x - 26 = 0$ .

**Solution**

Let  $f(x) = x^3 + 4x^2 + x - 26$ .

Then  $f(2) = 8 + 16 + 2 - 26 = 0$ .

Therefore  $x - 2$  is a factor of  $f(x)$ , and  $f(x) = (x - 2)(x^2 + 6x + 13)$ .

The quadratic in this expression has no simple roots, so using the quadratic formula on  $x^2 + 6x + 13 = 0$ ,

$$\begin{aligned}x &= \frac{-b \pm \sqrt{b^2 - 4ac}}{2a} \\&= \frac{-6 \pm \sqrt{36 - 52}}{2} \\&= \frac{-6 \pm 4i}{2} \\&= -3 \pm 2i.\end{aligned}$$

Hence the roots of  $f(x) = 0$  are 2 and  $-3 \pm 2i$ .

**Exercise 2B**

1. Solve the equations

(a)  $x^3 - x^2 - 5x - 3 = 0$ ,

(b)  $x^3 - 3x^2 + 4x - 2 = 0$ ,

(c)  $x^3 + 2x^2 - 3x - 10 = 0$ .

## 2.4 Relationship between the roots of a cubic equation and its coefficients

As a cubic equation has three roots, which may be real or complex, it follows that if the general cubic equation  $ax^3 + bx^2 + cx + d = 0$  has roots  $\alpha$ ,  $\beta$  and  $\gamma$ , it may be written as  $a(x - \alpha)(x - \beta)(x - \gamma) = 0$ . Note that the factor  $a$  is required to ensure that the coefficients of  $x^3$  are the same, so making the equations identical. Thus, on expanding the right hand side of the identity,

$$\begin{aligned} ax^3 + bx^2 + cx + d &\equiv a(x - \alpha)(x - \beta)(x - \gamma) \\ &\equiv ax^3 - a(\alpha + \beta + \gamma)x^2 + a(\alpha\beta + \beta\gamma + \gamma\alpha)x - a\alpha\beta\gamma. \end{aligned}$$

The two sides are identical so the coefficients of  $x^2$  and  $x$  can be compared, and also the number terms,

$$\begin{aligned} b &= -a(\alpha + \beta + \gamma) \\ c &= a(\alpha\beta + \beta\gamma + \gamma\alpha) \\ d &= -a\alpha\beta\gamma. \end{aligned}$$

If the cubic equation  $ax^3 + bx^2 + cx + d = 0$  has roots  $\alpha$ ,  $\beta$  and  $\gamma$ , then

$$\begin{aligned} \sum \alpha &= -\frac{b}{a}, \\ \sum \alpha\beta &= \frac{c}{a}, \\ \alpha\beta\gamma &= -\frac{d}{a} \end{aligned}$$

Note that  $\sum \alpha$  means the sum of all the roots, and that  $\sum \alpha\beta$  means the sum of all the possible products of roots taken two at a time.

### Exercise 2C

1. Find  $\sum \alpha$ ,  $\sum \alpha\beta$  and  $\alpha\beta\gamma$  for the following cubic equations:

(a)  $x^3 - 7x^2 + 12x + 5 = 0$ ,    (b)  $3x^3 + 4x^2 - 7x + 2 = 0$ .

2. The roots of a cubic equation are  $\alpha$ ,  $\beta$  and  $\gamma$ . If  $\sum \alpha = 3$ ,  $\sum \alpha\beta = \frac{7}{2}$  and  $\alpha\beta\gamma = -5$ , state the cubic equation.

## 2.5 Cubic equations with related roots

The example below shows how you can find equations whose roots are related to the roots of a given equation without having to find the actual roots. Two methods are given.

### Example 2.5.1

The cubic equation  $x^3 - 3x^2 + 4 = 0$  has roots  $\alpha$ ,  $\beta$  and  $\gamma$ . Find the cubic equations with:

- (a) roots  $2\alpha$ ,  $2\beta$  and  $2\gamma$ , (b) roots  $\alpha - 2$ ,  $\beta - 2$  and  $\gamma - 2$ , (c) roots  $\frac{1}{\alpha}$ ,  $\frac{1}{\beta}$  and  $\frac{1}{\gamma}$ .

**Solution: method 1**

From the given equation,

$$\begin{aligned}\sum \alpha &= 3 \\ \sum \alpha\beta &= 0 \\ \alpha\beta\gamma &= -4.\end{aligned}$$

- (a) Hence  $\sum 2\alpha = 2\sum \alpha = 6$   
 $\sum 2\alpha \cdot 2\beta = 4\sum \alpha\beta = 0$   
 $2\alpha \cdot 2\beta \cdot 2\gamma = 8\alpha\beta\gamma = -32.$

From which the equation of the cubic must be

$$\begin{aligned}x^3 - 6x^2 + 0x + 32 &= 0 \\ \text{or } x^3 - 6x^2 + 32 &= 0.\end{aligned}$$

- (b)  $\sum (\alpha - 2) = (\sum \alpha) - 6 = 3 - 6 = -3$   
 $\sum (\alpha - 2)(\beta - 2) = \sum \alpha\beta - 2\sum \alpha - 2\sum \beta + (4 \times 3)$   
 $= \sum \alpha\beta - 4\sum \alpha + 12$   
 $= 0 - 12 + 12 = 0.$   
 $(\alpha - 2)(\beta - 2)(\gamma - 2) = \alpha\beta\gamma - 2\sum \alpha\beta + 4\sum \alpha - 8$   
 $= -4 - 0 + 12 - 8$   
 $= 0.$

Hence the equation of the cubic must be  $x^3 + 3x^2 = 0$ .

(c)

$$\begin{aligned}\sum \frac{1}{\alpha} &= \frac{1}{\alpha} + \frac{1}{\beta} + \frac{1}{\gamma} \\ &= \frac{\sum \alpha\beta}{\alpha\beta\gamma} \\ &= \frac{0}{-4} = 0.\end{aligned}$$

$$\begin{aligned}\sum \frac{1}{\alpha} \cdot \frac{1}{\beta} &= \frac{1}{\alpha\beta} + \frac{1}{\beta\gamma} + \frac{1}{\gamma\alpha} \\ &= \frac{\sum \alpha}{\alpha\beta\gamma} \\ &= \frac{3}{-4} = -\frac{3}{4}.\end{aligned}$$

$$\frac{1}{\alpha} \cdot \frac{1}{\beta} \cdot \frac{1}{\gamma} = \frac{1}{-4} = -\frac{1}{4}.$$

So that the cubic equation with roots  $\frac{1}{\alpha}$ ,  $\frac{1}{\beta}$  and  $\frac{1}{\gamma}$  is

$$x^3 - 0x^2 - \frac{3}{4}x + \frac{1}{4} = 0$$

or  $4x^3 - 3x + 1 = 0.$

The second method of finding the cubic equations in Example 2.5.1 is shown below. It is not always possible to use this second method, but when you can it is much quicker than the first.

**Solution: method 2**

- (a) As the roots are to be  $2\alpha$ ,  $2\beta$  and  $2\gamma$ , it follows that, if  $X = 2x$ , then a cubic equation in  $X$  must have roots which are twice the roots of the cubic equation in  $x$ . As the equation in  $x$  is  $x^3 - 3x^2 + 4 = 0$ , if you substitute  $x = \frac{X}{2}$  the equation in  $X$  becomes

$$\left(\frac{X}{2}\right)^3 - 3\left(\frac{X}{2}\right)^2 + 4 = 0,$$

$$\text{or} \quad X^3 - 6X^2 + 32 = 0$$

as before.

- (b) In this case, if you put  $X = x - 2$  in  $x^3 - 3x^2 + 4 = 0$ , then any root of an equation in  $X$  must be 2 less than the corresponding root of the cubic in  $x$ . Now,  $X = x - 2$  gives  $x = X + 2$  and substituting into  $x^3 - 3x^2 + 4 = 0$  gives

$$(X + 2)^3 - 3(X + 2)^2 + 4 = 0$$

$$\text{which reduces to} \quad X^3 + 3X^2 = 0.$$

- (c) In this case you use the substitution  $X = \frac{1}{x}$  or  $x = \frac{1}{X}$ . For  $x^3 - 3x^2 + 4 = 0$  this gives

$$\left(\frac{1}{X}\right)^3 - 3\left(\frac{1}{X}\right)^2 + 4 = 0.$$

On multiplying by  $X^3$ , this gives

$$1 - 3X + 4X^3 = 0$$

$$\text{or} \quad 4X^3 - 3X + 1 = 0$$

as before.

**Exercise 2D**

1. The cubic equation  $x^3 - x^2 - 4x - 7 = 0$  has roots  $\alpha$ ,  $\beta$  and  $\gamma$ . Using the first method described above, find the cubic equations whose roots are

(a)  $3\alpha$ ,  $3\beta$  and  $3\gamma$ ,    (b)  $\alpha + 1$ ,  $\beta + 1$  and  $\gamma + 1$ ,    (c)  $\frac{2}{\alpha}$ ,  $\frac{2}{\beta}$  and  $\frac{2}{\gamma}$ .

2. Repeat Question 1 above using the second method described above.

3. Repeat Questions 1 and 2 above for the cubic equation  $2x^3 - 3x^2 + 6 = 0$ .

## 2.6 An important result

If you square  $\alpha + \beta + \gamma$  you get

$$\begin{aligned}(\alpha + \beta + \gamma)^2 &= (\alpha + \beta + \gamma)(\alpha + \beta + \gamma) \\ &= \alpha^2 + \alpha\beta + \alpha\gamma + \beta\alpha + \beta^2 + \beta\gamma + \gamma\alpha + \gamma\beta + \gamma^2 \\ &= \alpha^2 + \beta^2 + \gamma^2 + 2\alpha\beta + 2\beta\gamma + 2\gamma\alpha.\end{aligned}$$

So,  $(\sum \alpha)^2 = \sum \alpha^2 + 2\sum \alpha\beta$ , or

$$\sum \alpha^2 = (\sum \alpha)^2 - 2\sum \alpha\beta \text{ for three numbers } \alpha, \beta \text{ and } \gamma$$

This result is well worth remembering – it is frequently needed in questions involving the symmetric properties of roots of a cubic equation.

### Example 2.6.1

The cubic equation  $x^3 - 5x^2 + 6x + 1 = 0$  has roots  $\alpha, \beta$  and  $\gamma$ . Find the cubic equations with

(a) roots  $\beta\gamma, \gamma\alpha$  and  $\alpha\beta$ , (b) roots  $\alpha^2, \beta^2$  and  $\gamma^2$ .

[Note that the direct approach illustrated below is the most straightforward way of solving this type of problem.]

#### Solution

(a)

$$\sum \alpha = 5$$

$$\sum \alpha\beta = 6$$

$$\alpha\beta\gamma = -1$$

$$\sum \alpha\beta \cdot \beta\gamma = \sum \alpha\beta^2\gamma = \alpha\beta\gamma \sum \beta = \alpha\beta\gamma \sum \alpha = -1 \times 5 = -5.$$

$$\alpha\beta \cdot \beta\gamma \cdot \gamma\alpha = \alpha^2\beta^2\gamma^2 = (-1)^2 = +1.$$

Hence the cubic equation is  $x^3 - 6x^2 - 5x - 1 = 0$ .

(b)

$$\sum \alpha^2 = (\sum \alpha)^2 - 2\sum \alpha\beta = 5^2 - (2 \times 6) = 13.$$

$\sum \alpha^2\beta^2 = (\sum \alpha\beta)^2 - 2\sum \alpha\beta \cdot \beta\gamma$  using the same result but replacing  $\alpha$  with  $\alpha\beta$ ,  $\beta$  with  $\beta\gamma$ , and  $\gamma$  with  $\gamma\alpha$ .

$$\text{Thus } \sum \alpha^2\beta^2 = (\sum \alpha\beta)^2 - 2\sum \alpha\beta^2\gamma$$

$$= (\sum \alpha\beta)^2 - 2\alpha\beta\gamma \sum \alpha = 36 - (2 \times -1 \times 5) = 46.$$

$$\alpha^2\beta^2\gamma^2 = (-1)^2 = 1.$$

Hence the cubic equation is  $x^3 - 13x^2 + 46x - 1 = 0$ .

## 2.7 Polynomial equations of degree $n$

The ideas covered so far on quadratic and cubic equations can be extended to equations of any degree. An equation of degree 2 has two roots, one of degree 3 has three roots – so an equation of degree  $n$  has  $n$  roots.

Suppose the equation  $ax^n + bx^{n-1} + cx^{n-2} + dx^{n-3} \dots + k = 0$  has  $n$  roots  $\alpha, \beta, \gamma, \dots$  then

$$\sum \alpha = -\frac{b}{a},$$

$$\sum \alpha\beta = \frac{c}{a},$$

$$\sum \alpha\beta\gamma = -\frac{d}{a},$$

until, finally, the product of the  $n$  roots  $\alpha\beta\gamma \dots = \frac{(-1)^n k}{a}$ .

Remember that  $\sum \alpha\beta$  is the sum of the products of all possible pairs of roots,  $\sum \alpha\beta\gamma$  is the sum of the products of all possible combinations of roots taken three at a time, and so on.

In practice, you are unlikely to meet equations of degree higher than 4 so this section concludes with an example using a quartic equation.

### Example 2.7.1

The quartic equation  $2x^4 + 4x^3 - 6x^2 + x - 1 = 0$  has roots  $\alpha, \beta, \gamma$  and  $\delta$ . Write down

(a)  $\sum \alpha$ , (b)  $\sum \alpha\beta$ .

(c) Hence find  $\sum \alpha^2$ .

#### Solution

(a)  $\sum \alpha = \alpha + \beta + \gamma + \delta = \frac{-4}{2} = -2.$

(b)  $\sum \alpha\beta = \alpha\beta + \beta\gamma + \gamma\delta + \delta\alpha + \alpha\gamma + \beta\delta = \frac{-6}{2} = -3.$

(c) Now  $(\sum \alpha)^2 = (\alpha + \beta + \gamma + \delta)^2$   
 $= \alpha^2 + \beta^2 + \gamma^2 + \delta^2 + 2(\alpha\beta + \beta\gamma + \gamma\delta + \delta\alpha + \alpha\gamma + \beta\delta)$   
 $= \sum \alpha^2 + 2\sum \alpha\beta.$

This shows that the ‘important result’ in Section 2.6 can be extended to any number of letters.

Hence  $\sum \alpha^2 = (\sum \alpha)^2 - 2\sum \alpha\beta$   
 $= (-2)^2 - 2(-3)$   
 $= 10.$



**Exercise 2E**

1. The quartic equation  $2x^4 - 3x^2 + 5x - 8 = 0$  has roots  $\alpha, \beta, \gamma$  and  $\delta$ .

(a) Find the equation with roots  $\frac{\alpha}{2}, \frac{\beta}{2}, \frac{\gamma}{2}$  and  $\frac{\delta}{2}$ .

(b) Find  $\sum \alpha^2$ .

**2.8 Complex roots of polynomial equations with real coefficients**

Consider the polynomial equation  $f(x) = ax^n + bx^{n-1} + cx^{n-2} \dots + k$ . Using the ideas from Chapter 1, if  $p$  and  $q$  are real,

$$\begin{aligned} f(p+iq) &= a(p+iq)^n + b(p+iq)^{n-1} + \dots + k \\ &= u+iv, \quad \text{where } u \text{ and } v \text{ are real.} \end{aligned}$$

Now, 
$$\begin{aligned} f(p-iq) &= a(p-iq)^n + b(p-iq)^{n-1} + \dots + k \\ &= u-iv \end{aligned}$$

since  $-i$  raised to an even power is real and is the same as  $+i$  raised to an even power, making the real part of  $f(p-iq)$  the same as the real part of  $f(p+iq)$ . But  $-i$  raised to an odd power is the same as  $+i$  raised to an odd power multiplied by  $-1$ , and odd powers of  $i$  comprise the imaginary part of  $f(p-iq)$ . Thus, the imaginary part of  $f(p-iq)$  is  $-1$  times the imaginary part of  $f(p+iq)$ .

Now if  $p+iq$  is a root of  $f(x) = 0$ , it follows that  $u+iv = 0$  and so  $u = 0$  and  $v = 0$ . Hence,  $u-iv = 0$  making  $f(p-iq) = 0$  and  $p-iq$  a root of  $f(x) = 0$ .

If a polynomial equation has **real** coefficients and if  $p+iq$ , where  $p$  and  $q$  are real, is a root of the polynomial, then its complex conjugate,  $p-iq$ , is also a root of the equation

It is very important to note that the coefficients in  $f(x) = 0$  must be real. If  $f(x) = 0$  has complex coefficients, this result does not apply.

**Example 2.8.1**

The cubic equation  $x^3 - 3x^2 + x + k = 0$ , where  $k$  is real, has one root equal to  $2 - i$ . Find the other two roots and the value of  $k$ .

**Solution**

As the coefficients of the cubic equation are real, it follows that  $2 + i$  is also a root.

Considering the sum of the roots of the equation, if  $\gamma$  is the third root,

$$(2 - i) + (2 + i) + \gamma = -\frac{-3}{1} = 3,$$

$$\gamma = -1.$$

To find  $k$ ,

$$-k = \alpha\beta\gamma = (2 - i)(2 + i)(-1) = -5,$$

$$k = 5.$$

**Example 2.8.2**

The quartic equation  $x^4 + 2x^3 + 14x + 15 = 0$  has one root equal to  $1 + 2i$ . Find the other three roots.

**Solution**

As the coefficients of the quartic are real, it follows that  $1 - 2i$  is also a root.

Hence  $[x - (1 + 2i)][x - (1 - 2i)]$  is a quadratic factor of the quartic. Now,

$$\begin{aligned} [x - (1 + 2i)][x - (1 - 2i)] &= x^2 - x(1 + 2i) - x(1 - 2i) + (1 + 2i)(1 - 2i) \\ &= x^2 - 2x + 5. \end{aligned}$$

Hence  $x^2 - 2x + 5$  is a factor of  $x^4 + 2x^3 + 14x + 15$ .

Therefore  $x^4 + 2x^3 + 14x + 15 = (x^2 - 2x + 5)(x^2 + ax + b)$ .

Comparing the coefficients of  $x^3$ ,

$$2 = a - 2$$

$$a = 4.$$

Considering the number terms,

$$15 = 3b$$

$$b = 5.$$

Hence the quartic equation may be written as

$$(x^2 - 2x + 5)(x^2 + 4x + 3) = 0$$

$$(x^2 - 2x + 5)(x + 3)(x + 1) = 0,$$

and the four roots are  $1 + 2i$ ,  $1 - 2i$ ,  $-3$  and  $-1$ .

**Exercise 2F**

1. A cubic equation has real coefficients. One root is 2 and another is  $1+i$ . Find the cubic equation in the form  $x^3 + ax^2 + bx + c = 0$ .
2. The cubic equation  $x^3 - 2x^2 + 9x - 18 = 0$  has one root equal to  $3i$ . Find the other two roots.
3. The quartic equation  $4x^4 - 8x^3 + 9x^2 - 2x + 2 = 0$  has one root equal to  $1-i$ . Find the other three roots.

**Miscellaneous exercises 2**

1. The equation

$$x^3 - 3x^2 + px + 4 = 0,$$

where  $p$  is a constant, has roots  $\alpha - \beta$ ,  $\alpha$  and  $\alpha + \beta$ , where  $\beta > 0$ .

(a) Find the values of  $\alpha$  and  $\beta$ .

(b) Find the value of  $p$ .

[NEAB June 1998]

2. The numbers  $\alpha$ ,  $\beta$  and  $\gamma$  satisfy the equations

$$\alpha^2 + \beta^2 + \gamma^2 = 22$$

and

$$\alpha\beta + \beta\gamma + \gamma\alpha = -11.$$

(a) Show that  $\alpha + \beta + \gamma = 0$ .

(b) The numbers  $\alpha$ ,  $\beta$  and  $\gamma$  are also the roots of the equation

$$x^3 + px^2 + qx + r = 0,$$

where  $p$ ,  $q$  and  $r$  are real.

(i) Given that  $\alpha = 3 + 4i$  and that  $\gamma$  is real, obtain  $\beta$  and  $\gamma$ .

(ii) Calculate the product of the three roots.

(iii) Write down, or determine, the values of  $p$ ,  $q$  and  $r$ .

[AQA June 2000]

3. The roots of the cubic equation

$$2x^3 + 3x + 4 = 0$$

are  $\alpha$ ,  $\beta$  and  $\gamma$ .

(a) Write down the values of  $\alpha + \beta + \gamma$ ,  $\alpha\beta + \beta\gamma + \gamma\alpha$  and  $\alpha\beta\gamma$ .

(b) Find the cubic equation, with integer coefficients, having roots  $\alpha\beta$ ,  $\beta\gamma$  and  $\gamma\alpha$ .

[AQA March 2000]

4. The roots of the equation

$$7x^3 - 8x^2 + 23x + 30 = 0$$

are  $\alpha$ ,  $\beta$  and  $\gamma$ .

(a) Write down the value of  $\alpha + \beta + \gamma$ .

(b) Given that  $1 + 2i$  is a root of the equation, find the other two roots.

[AQA Specimen]

5. The roots of the cubic equation

$$x^3 + px^2 + qx + r = 0,$$

where  $p$ ,  $q$  and  $r$  are real, are  $\alpha$ ,  $\beta$  and  $\gamma$ .

(a) Given that  $\alpha + \beta + \gamma = 3$ , write down the value of  $p$ .

(b) Given also that

$$\alpha^2 + \beta^2 + \gamma^2 = -5,$$

(i) find the value of  $q$ ,

(ii) explain why the equation must have two non-real roots and one real root.

(c) One of the two non-real roots of the cubic equation is  $3 - 4i$ .

(i) Find the real root.

(ii) Find the value of  $r$ .

[AQA March 1999]

6. (a) Prove that when a polynomial  $f(x)$  is divided by  $x - a$ , the remainder is  $f(a)$ .

(b) The polynomial  $g(x)$  is defined by

$$g(x) = 16x^5 + px^3 + qx^2 - 12x - 1,$$

where  $p$  and  $q$  are real constants. When  $g(x)$  is divided by  $x - i$ , where  $i = \sqrt{-1}$ , the remainder is 3.

(i) Find the values of  $p$  and  $q$ .

(ii) Show that when  $g(x)$  is divided by  $2x - i$ , the remainder is  $-6i$ .

[AQA June 1999]

## Chapter 3: Summation of Finite Series

- 3.1 Introduction
- 3.2 Summation of series by the method of differences
- 3.3 Summation of series by the method of induction
- 3.4 Proof by induction extended to other areas of mathematics

---

This chapter extends the idea of summation of simple series, with which you are familiar from earlier studies, to other kinds of series. When you have completed it, you will:

- know new methods of summing series;
- know which method is appropriate for the summation of a particular series;
- understand an important method known as the method of induction;
- be able to apply the method of induction in circumstances other than in the summation of series.

### 3.1 Introduction

You should already be familiar with the idea of a series – a series is the sum of the terms of a sequence. That is, the sum of a number of terms where the terms follow a definite pattern.

For instance, the sum of an arithmetic progression is a series. In this case each term is bigger than the preceding term by a constant number – this constant number is usually called the **common difference**. Thus,

$$2 + 5 + 8 + 11 + 14$$

is a series of 5 terms, in arithmetic progression, with common difference 3.

The sum of a geometric progression is also a series. Instead of adding a fixed number to find the next consecutive number in the series, you multiply by a fixed number (called the **common ratio**). Thus,

$$2 + 6 + 18 + 54 + 162 + 486$$

is a series of 6 terms, in geometric progression, with common ratio 3.

A **finite series** is a series with a finite number of terms. The two series above are examples of finite series.

### 3.2 Summation of series by the method of differences

Some problems require you to find the sum of a given series, for example

$$\text{sum the series } \frac{1}{1 \times 2} + \frac{1}{2 \times 3} + \frac{1}{3 \times 4} + \dots + \frac{1}{n(n+1)}.$$

In others you have to show that the sum of a series is a specific number or a given expression. An example of this kind of problem is

$$\text{show that } \frac{1}{1 \times 2} + \frac{1}{2 \times 3} + \frac{1}{3 \times 4} + \dots + \frac{1}{n(n+1)} = 1 - \frac{1}{n+1}.$$

The **method of differences** is usually used when the sum of the series is not given. Suppose you want to find the sum,  $\sum_{r=1}^n u_r$ , of a series

$$u_1 + u_2 + u_3 + \dots + u_n$$

where the terms follow a certain pattern. The aim in the method of differences is to express the  $r^{\text{th}}$  term, which will be a function of  $r$  (just as  $\frac{1}{r(r+1)}$  is the  $r^{\text{th}}$  term of the first series

above), as the difference of two expressions in  $r$  of the same form. In other words,  $u_r$  is expressed as  $f(r) - f(r+1)$ , or possibly  $f(r+1) - f(r)$ , where  $f(r)$  is some function of  $r$ . If you can express  $u_r$  in this way, it can be seen that setting  $r = 1$  and then  $r = 2$  gives

$$\begin{aligned} u_1 + u_2 &= f(1) - f(2) + f(2) - f(3) \\ &= f(1) - f(3). \end{aligned}$$

If this idea is extended to the whole series, then

$$\begin{array}{ll} r = 1 & u_1 = f(1) - f(2) \\ r = 2 & u_2 = f(2) - f(3) \\ r = 3 & u_3 = f(3) - f(4) \\ \vdots & \vdots \\ r = n-1 & u_{n-1} = f(n-1) - f(n) \\ r = n & u_n = f(n) - f(n+1) \end{array}$$

Now, adding these terms gives

$$\begin{aligned} u_1 + u_2 + u_3 + \dots + u_{n-1} + u_n &= f(1) - f(2) + f(2) - f(3) + f(3) - f(4) + f(4) \\ &\quad \dots + f(n-1) - f(n) + f(n) - f(n+1). \end{aligned}$$

The left hand side of this expression is the required sum of the series,  $\sum_{r=1}^n u_r$ . On the right hand side, nearly all the terms cancel out:  $f(2), f(3), f(4), \dots, f(n)$  all cancel leaving just  $f(1) - f(n+1)$  as the sum of the series.



**Example 3.2.1**

Find the sum of the series  $\frac{1}{1 \times 2} + \frac{1}{2 \times 3} + \frac{1}{3 \times 4} + \dots + \frac{1}{n(n+1)}$ .

**Solution**

Clearly, this is not a familiar standard series, such as an arithmetic or geometric series. Nor is the answer given. So it seems that the method of differences can be applied.

As above, the  $r^{\text{th}}$  term,  $u_r$ , is given by  $\frac{1}{r(r+1)}$ . We need to try to split up  $u_r$ . The only

sensible way to do this is to express  $\frac{1}{r(r+1)}$  in partial fractions. Suppose

$$\frac{1}{r(r+1)} = \frac{A}{r} + \frac{B}{r+1}.$$

Then,  $1 = A(r+1) + Br$ . Comparing the coefficients of  $r$ ,  $A + B = 0$ . Comparing the constant terms,  $A = 1$ . Hence  $B = -1$  and

$$u_r = \frac{1}{r(r+1)} = \frac{1}{r} - \frac{1}{r+1}.$$

Hence, in this case the  $f(r)$  mentioned previously would be  $\frac{1}{r}$ , with  $f(r+1) = \frac{1}{r+1}$ , and so on. Now, writing down the series term by term,

$r = 1$	$\frac{1}{1 \times 2} = \frac{1}{1} - \frac{1}{1+1}$	$= \frac{1}{1} - \frac{1}{2}$
$r = 2$	$\frac{1}{2 \times 3} = \frac{1}{2} - \frac{1}{2+1}$	$= \frac{1}{2} - \frac{1}{3}$
$r = 3$	$\frac{1}{3 \times 4} = \frac{1}{3} - \frac{1}{3+1}$	$= \frac{1}{3} - \frac{1}{4}$
$\vdots$	$\vdots$	$\vdots$
$r = n-1$	$\frac{1}{(n-1)n} = \frac{1}{n-1} - \frac{1}{(n-1)+1}$	$= \frac{1}{n-1} - \frac{1}{n}$
$r = n$	$\frac{1}{n(n+1)}$	$= \frac{1}{n} - \frac{1}{n+1}$

Adding the columns, the left hand side becomes  $\sum_{r=1}^n \frac{1}{r(r+1)}$ . Because the  $\frac{1}{2}, \frac{1}{3}, \dots$  etc. terms

cancel, the right hand side becomes  $\frac{1}{1} - \frac{1}{n+1}$ , namely the first left hand side term and the last right hand side term. Hence,

$$\begin{aligned} \sum_{r=1}^n \frac{1}{r(r+1)} &= 1 - \frac{1}{n+1} \\ &= \frac{(n+1) - 1}{n+1} \\ &= \frac{n}{n+1}. \end{aligned}$$

**Example 3.2.2**

Show that  $r^2(r+1)^2 - (r-1)^2 r^2 \equiv 4r^3$ . Hence find  $\sum_{r=1}^n r^3$ .

**Solution**

The left hand side of the identity has a common factor,  $r^2$ .

$$\begin{aligned} r^2(r+1)^2 - (r-1)^2 r^2 &\equiv r^2 \left[ (r+1)^2 - (r-1)^2 \right] \\ &= r^2 \left[ (r^2 + 2r + 1) - (r^2 - 2r + 1) \right] \\ &= r^2 \left[ r^2 + 2r + 1 - r^2 + 2r - 1 \right] \\ &= r^2 (4r) \\ &= 4r^3. \end{aligned}$$

Now, if  $f(r) = (r-1)^2 r^2$ , then

$$\begin{aligned} f(r+1) &= (r+1-1)^2 (r+1)^2 \\ &= r^2 (r+1)^2, \end{aligned}$$

so that  $4r^3$  is of the form  $f(r+1) - f(r)$ . Listing the terms in columns, as in Example 3.2.1,

$r = 1$	$4 \times 1^3$	$=$	<del><math>(1^2 \times 2^2)</math></del> <span style="background-color: #cccccc;"><math>-(0^2 \times 1^2)</math></span>
$r = 2$	$4 \times 2^3$	$=$	<del><math>(2^2 \times 3^2)</math></del> <del><math>-(1^2 \times 2^2)</math></del>
$r = 3$	$4 \times 3^3$	$=$	<del><math>(3^2 \times 4^2)</math></del> <del><math>-(2^2 \times 3^2)</math></del>
$\vdots$	$\vdots$		$\vdots$
$r = (n-1)$	$4 \times (n-1)^3$	$=$	<del><math>(n-1)^2 n^2</math></del> <del><math>-(n-2)^2 (n-1)^2</math></del>
$r = n$	$4 \times n^3$	$=$	<span style="background-color: #cccccc;"><math>n^2 (n+1)^2</math></span> <del><math>-(n-1)^2 n^2</math></del>

Adding the columns, it can be seen that the left hand side is

$$(4 \times 1^3) + (4 \times 2^3) + (4 \times 3^3) + \dots + 4n^3 = 4 \sum_{r=1}^n r^3.$$

Summing the right hand side, all the terms cancel out except those shaded in the scheme above, so the sum is  $n^2(n+1)^2 - (0^2 \times 1^2)$ . Hence,

$$\begin{aligned} 4 \sum_{r=1}^n r^3 &= n^2(n+1)^2 - (0^2 \times 1^2) \\ &= n^2(n+1)^2. \end{aligned}$$

Hence,  $\sum_{r=1}^n r^3 = \frac{1}{4} n^2(n+1)^2$ , as required.

In both Examples 3.2.1 and 3.2.2, one term on each line cancelled out with a term on the next line when the addition was done. Some series may be such that a term in one line cancels with a term on a line two rows below it.

### Example 3.2.3

Sum the series  $\frac{1}{1 \times 5} + \frac{1}{3 \times 7} + \frac{1}{5 \times 9} + \dots + \frac{1}{(2n-1)(2n+3)}$ .

#### Solution

As in Example 3.2.1, the way forward is to express  $\frac{1}{(2n-1)(2n+3)}$  in partial fractions.

$$\text{Let } \frac{1}{(2r-1)(2r+3)} = \frac{A}{2r-1} + \frac{B}{2r+3}.$$

Multiplying both sides by  $(2r-1)(2r+3)$ ,

$$1 \equiv A(2r+3) + B(2r-1).$$

Comparing the coefficients of  $r$ ,  $2A + 2B = 0$ , so  $A = -B$ . Comparing the constant terms,  $1 = 3A - B$ . Hence  $A = \frac{1}{4}$  and  $B = -\frac{1}{4}$ . Thus,

$$\frac{1}{(2r-1)(2r+3)} = \frac{1}{4} \left( \frac{1}{2r-1} \right) - \frac{1}{4} \left( \frac{1}{2r+3} \right).$$

Now substitute  $r = 1, 2, 3, \dots$

$$r = 1 \quad \frac{1}{1 \times 5} \quad = \frac{1}{4} \left( \frac{1}{1} \right) - \frac{1}{4} \left( \frac{1}{5} \right)$$

$$r = 2 \quad \frac{1}{3 \times 7} \quad = \frac{1}{4} \left( \frac{1}{3} \right) - \frac{1}{4} \left( \frac{1}{7} \right)$$

[note that nothing will cancel at this stage]

$$r = 3 \quad \frac{1}{5 \times 9} \quad = \frac{1}{4} \left( \frac{1}{5} \right) - \frac{1}{4} \left( \frac{1}{9} \right)$$

[note that  $\frac{1}{4} \left( \frac{1}{5} \right)$  will cancel on the first row and the third row]

$$r = 4 \quad \frac{1}{7 \times 11} \quad = \frac{1}{4} \left( \frac{1}{7} \right) - \frac{1}{4} \left( \frac{1}{11} \right)$$

$$\vdots \quad \quad \quad \vdots \quad \quad \quad \vdots$$

$$r = (n-2) \quad \frac{1}{(2n-5)(2n-1)} \quad = \frac{1}{4} \left( \frac{1}{2n-5} \right) - \frac{1}{4} \left( \frac{1}{2n-1} \right)$$

$$r = (n-1) \quad \frac{1}{(2n-3)(2n+1)} \quad = \frac{1}{4} \left( \frac{1}{2n-3} \right) - \frac{1}{4} \left( \frac{1}{2n+1} \right)$$

$$r = n \quad \frac{1}{(2n-1)(2n+3)} \quad = \frac{1}{4} \left( \frac{1}{2n-1} \right) - \frac{1}{4} \left( \frac{1}{2n+3} \right)$$

There will be two terms left at the beginning of the series when the columns are added,  $\frac{1}{4}\left(\frac{1}{1}\right)$  and  $\frac{1}{4}\left(\frac{1}{3}\right)$ . Likewise, there will be two terms left at the end of the series – the right hand part of the  $r = n - 1$  and  $r = n$  rows.

Therefore, addition gives

$$\begin{aligned} \frac{1}{1 \times 5} + \frac{1}{3 \times 7} + \frac{1}{5 \times 9} + \dots + \frac{1}{(2n-1)(2n+3)} &= \frac{1}{4}\left(\frac{1}{1}\right) + \frac{1}{4}\left(\frac{1}{3}\right) - \frac{1}{4}\left(\frac{1}{2n-1}\right) - \frac{1}{4}\left(\frac{1}{2n+3}\right) \\ &= \frac{1}{4}\left[1 + \frac{1}{3} - \left(\frac{1}{2n+1} + \frac{1}{2n+3}\right)\right] \\ &= \frac{1}{4}\left[\frac{4}{3} - \left(\frac{2n+3+2n+1}{(2n+1)(2n+3)}\right)\right] \\ &= \frac{1}{4}\left[\frac{4}{3} - \left(\frac{4(n+1)}{(2n+1)(2n+3)}\right)\right] \\ &= \frac{1}{3} - \left(\frac{n+1}{(2n+1)(2n+3)}\right). \end{aligned}$$

### Exercise 3A

1. (a) Simplify  $r(r+1) - (r-1)r$ .  
 (b) Use your result to obtain  $\sum_{r=1}^n r$ .
  
2. (a) Show that  $\frac{1}{r(r+1)(r+2)} - \frac{1}{(r+1)(r+2)(r+3)} = \frac{3}{r(r+1)(r+2)(r+3)}$ .  
 (b) Hence sum the series  $\sum_{r=1}^n \frac{1}{r(r+1)(r+2)(r+3)}$ .
  
3. (a) Show that  $(r+1)^3 - (r-1)^3 = 6r^2 + 2$ .  
 (b) Deduce  $\sum_{r=1}^n r^2$ .

### 3.3 Summation of a series by the method of induction

The method of induction is a method of summing a series of, say,  $n$  terms when the sum is given in terms of  $n$ . Suppose you have to show that the sum of  $n$  terms of a series is  $S(n)$ . If you assume that the summation is true for one particular integer, say  $k$ , where  $k < n$ , then you are assuming that the sum of the first  $k$  terms is  $S(k)$ . You may think that this rather begs the question but it must be understood that the result is assumed to be true for only **one** value of  $n$ , namely  $n = k$ . You then use this assumption to **prove** that the sum of the series to  $k + 1$  terms is  $S(k + 1)$  – that is to say that by adding one extra term, the next term in the series, the sum has exactly the same form as  $S(n)$  but with  $n$  replaced by  $k + 1$ . Finally, it is demonstrated that the result is true for  $n = 1$ . To summarise:

- 1 Assume that the result of the summation is true for  $n = k$  and prove that it is true for  $n = k + 1$
- 2 Prove that the result is true for  $n = 1$

Statement 1 shows that, by putting  $k = 1$  (which is known to be true from Statement 2), the result must be true for  $n = 2$ ; and Statement 1 shows that by putting  $k = 2$  the result must be true for  $n = 3$ ; and so on. By building up the result, it can be said that the summation result is true for all positive integers  $n$ .

There is a formal way of writing out the method of induction which is shown in the examples below. For convenience, and comparison, the examples worked in Section 3.2 are used again here.

#### Example 3.3.1

Show that  $\sum_{r=1}^n \frac{1}{r(r+1)} = \frac{n}{n+1}$ .

#### Solution

Assume that the result is true for  $n = k$ ; that is to say

$$\frac{1}{1 \times 2} + \frac{1}{2 \times 3} + \frac{1}{3 \times 4} + \dots + \frac{1}{k(k+1)} = \frac{k}{k+1}.$$

Adding the next term to both sides,

$$\frac{1}{1 \times 2} + \frac{1}{2 \times 3} + \frac{1}{3 \times 4} + \dots + \frac{1}{k(k+1)} + \frac{1}{(k+1)(k+2)} = \frac{k}{k+1} + \frac{1}{(k+1)(k+2)}.$$

Then

$$\begin{aligned} \sum_{r=1}^{k+1} \frac{1}{r(r+1)} &= \frac{k}{k+1} + \frac{1}{(k+1)(k+2)} \\ &= \frac{k(k+2)+1}{(k+1)(k+2)} \\ &= \frac{k^2+2k+1}{(k+1)(k+2)} \end{aligned}$$

$$\begin{aligned}
 &= \frac{(k+1)(k+1)}{(k+1)(k+2)} \\
 &= \frac{k+1}{k+2} \\
 &= \frac{k+1}{(k+1)+1},
 \end{aligned}$$

which is of the same form but with  $k+1$  replacing  $k$ . Hence, if the result is true for  $n=k$ , it is true for  $n=k+1$ . But it is true for  $n=1$  because the left hand side is  $\frac{1}{1 \times 2} = \frac{1}{2}$ , and the right hand side is  $\frac{1}{1+1} = \frac{1}{2}$ . Therefore the result is true for all positive integers by induction.

### Example 3.3.2

Show that  $\sum_{r=1}^n r^3 = \frac{1}{4}n^2(n+1)^2$ .

#### Solution

Assume that the result is true for  $n=k$ , that is to say

$$\sum_{r=1}^k r^3 = \frac{1}{4}k^2(k+1)^2.$$

Then, adding the next term to both sides

$$\begin{aligned}
 \sum_{r=1}^{k+1} r^3 &= \frac{1}{4}k^2(k+1)^2 + (k+1)^3 \\
 &= \frac{1}{4}(k+1)^2 [k^2 + 4(k+1)] \\
 &= \frac{1}{4}(k+1)^2 [k^2 + 4k + 4] \\
 &= \frac{1}{4}(k+1)^2 (k+2)^2 \\
 &= \frac{1}{4}(k+1)^2 [(k+1)+1]^2,
 \end{aligned}$$

which is of the same form but with  $k+1$  replacing  $k$ . Hence, if the result is true for  $n=k$ , it is true for  $n=k+1$ . But it is true for  $k=1$  because the left hand side is  $1^3 = 1$ , and the right hand side is  $\frac{1}{4} \times 1^2 \times 2^2 = 1$ . Therefore the result is true for all positive integers by induction.

**Exercise 3B**

1. Prove the following results by the method of induction:

(a)  $(1 \times 2) + (2 \times 3) + (3 \times 4) + \dots + n(n+1) = \frac{1}{3}n(n+1)(n+2)$ .

(b)  $1^2 + 2^2 + 3^2 + \dots + n^2 = \frac{1}{6}n(n+1)(2n+1)$ .

(c)  $\sum_{r=1}^n r(r+2) = \frac{1}{6}n(n+1)(2n+7)$ .

(d)  $\sum_{r=1}^n r \times r! = (n+1)! - 1$ .

### 3.4 Proof by induction extended to other areas of mathematics

The method of induction is certainly useful in the summation of series but it is not confined to this area of mathematics. This chapter concludes with a look at its use in three other connections – sequences, divisibility and de Moivre's theorem for positive integers.

**Example 3.4.1** – application to sequences

A sequence  $u_1, u_2, u_3, \dots$  is defined by  $u_1 = 3$        $u_{n+1} = 3 - \frac{2}{u_n}$       ( $n \geq 1$ ).

Prove by induction that for all  $n \geq 1$ ,  $u_n = \frac{2^{n+1} - 1}{2^n - 1}$ .

#### **Solution**

Assume that the result is true for  $n = k$ , that is to say

$$u_k = \frac{2^{k+1} - 1}{2^k - 1}.$$

Then, using the relationship given,

$$\begin{aligned} u_{k+1} &= 3 - \frac{2}{u_k} \\ &= 3 - \frac{2}{\frac{2^{k+1} - 1}{2^k - 1}} \\ &= 3 - \frac{2(2^k - 1)}{2^{k+1} - 1} \\ &= \frac{3(2^{k+1} - 1) - 2(2^k - 1)}{2^{k+1} - 1} \\ &= \frac{(3 \times 2^{k+1}) - 3 - 2^{k+1} + 2}{2^{k+1} - 1} \\ &= \frac{(2 \times 2^{k+1}) - 1}{2^{k+1} - 1} \\ &= \frac{2^{k+2} - 1}{2^{k+1} - 1} \\ &= \frac{2^{(k+1)+1} - 1}{2^{k+1} - 1}. \end{aligned}$$

which is of the same form as  $u_k$  but with  $k + 1$  replacing  $k$ . Hence, if the result is true for

$n = k$ , it is true for  $n = k + 1$ . But when  $k = 1$ ,  $u_1 = \frac{2^{1+1} - 1}{2^1 - 1} = 3$  as given. Therefore the result is true for all positive integers  $n \geq 1$  by induction.



**Example 3.4.2** – application to divisibility

Prove by induction that if  $n$  is a positive integer,  $3^{2n} + 7$  is divisible by 8.

**Solution**

The best approach is a little different to that used so far.

Assume that the result is true for  $n = k$ , in other words that

$$3^{2k} + 7 \text{ is divisible by } 8.$$

When  $n = k + 1$  the expression is  $3^{2(k+1)} + 7$ . Consider  $3^{2(k+1)} + 7 - (3^{2k} + 7)$ , the difference between the values when  $n = k$  and  $n = k + 1$ . This expression is equal to  $3^{2(k+1)} - 3^{2k}$

$$\begin{aligned} &= 3^{2k+2} - 3^{2k} \\ &= (3^{2k} \times 3^2) - 3^{2k} \\ &= 3^{2k} (3^2 - 1) \\ &= 8 \times 3^{2k}. \end{aligned}$$

Thus, if  $3^{2k} + 7$  is divisible by 8, and clearly  $8 \times 3^{2k}$  is divisible by 8, it follows that  $3^{2(k+1)} + 7$  is also divisible by 8. In other words, if the result is true for  $n = k$ , it is true for  $n = k + 1$ . But for  $n = 1$ ,  $3^2 + 7 = 16$  and is divisible by 8. Hence,  $3^{2n} + 7$  is divisible by 8 for all positive integers  $n$  by induction.

**Example 3.4.3** – application to de Moivre’s theorem for positive integers.

Prove by induction that for integers  $n \geq 1$ ,  $(\cos \theta + i \sin \theta)^n = \cos n\theta + i \sin n\theta$ .

**Solution**

Assume that the result is true for  $n = k$ , that is to say

$$(\cos \theta + i \sin \theta)^k = \cos k\theta + i \sin k\theta.$$

Multiplying both sides by  $\cos \theta + i \sin \theta$ ,

$$\begin{aligned} (\cos \theta + i \sin \theta)^k (\cos \theta + i \sin \theta) &= (\cos k\theta + i \sin k\theta)(\cos \theta + i \sin \theta) \\ (\cos \theta + i \sin \theta)^{k+1} &= \cos k\theta \cos \theta + i \sin k\theta \cos \theta + i \sin \theta \cos k\theta + i^2 \sin k\theta \sin \theta \\ &= (\cos k\theta \cos \theta - \sin k\theta \sin \theta) + i(\sin k\theta \cos \theta + \cos k\theta \sin \theta) \quad [i^2 = -1] \\ &= \cos(k+1)\theta + i \sin(k+1)\theta, \end{aligned}$$

which is of the same form but with  $k + 1$  replacing  $k$ . Hence, if the result is true for  $n = k$  it is true for  $n = k + 1$ . But when  $k = 1$ ,  $(\cos \theta + i \sin \theta)^1 = \cos \theta + i \sin \theta$ . Therefore the result is true for all positive integers  $n$  by induction.

**Exercise 3C**

1. Prove the following results by the method of induction – in all examples  $n$  is a positive integer:

(a)  $n^3 - n$  is divisible by 6.

(b)  $12^n + 2 \times 5^{n-1}$  is divisible by 7. [Hint: consider  $f(n+1) - 5f(n)$  where  $f(n) = 12^n + 2 \times 5^{n-1}$ ]

(c)  $\frac{d}{dx}(x^n) = nx^{n-1}$ . [Hint: use the formula for differentiating a product]

(d)  $x^n - 1$  is divisible by  $x - 1$ .

**Miscellaneous exercises 3**

1. Use the identity  $\frac{1}{r(r+1)} = \frac{1}{r} - \frac{1}{r+1}$

to show that  $\sum_{r=1}^n \frac{1}{r(r+1)} = \frac{n}{n+1}$ .

[AQA June 1999]

2. (a) Use the identity  $4r^3 = r^2(r+1) - (r-1)^2 r^2$

to show that  $\sum_{r=1}^n 4r^3 = n^2(n+1)^2$ .

(b) Hence find  $\sum_{r=1}^n 2r(2r^2 + 1)$ ,

giving your answer as a product of three factors in terms of  $n$ .

[AQA June 2000]

3. Prove by induction that

$$\sum_{r=1}^n r \times 3^{r-1} = \frac{1}{4} + \frac{3^n}{4}(2n-1).$$

[AQA March 1999]

4. Prove by induction, or otherwise, that

$$\sum_{r=1}^n (r \times r!) = (n+1)! - 1.$$

[NEAB June 1998]

5. Prove by induction that for all integers  $n \geq 0$ ,  $7^n + 2$  is divisible by 3.

[AQA Specimen]

6. Use mathematical induction to prove that

$$\sum_{r=1}^n (r-1)(3r-2) = n^2(n-1)$$

for all positive integers  $n$ .

[AEB June 1997]

7. A sequence  $u_1, u_2, u_3, \dots$  is defined by

$$u_1 = 2,$$

$$u_{n+1} = 2 - \frac{1}{u_n}, \quad n \geq 1.$$

Prove by induction that for all  $n \geq 1$ ,

$$u_n = \frac{n+1}{n}.$$

[AQA June 1999]

8. Verify the identity  $\frac{2r-1}{r(r-1)} - \frac{2r+1}{r(r+1)} \equiv \frac{2}{(r-1)(r+1)}$ .

Hence, using the method of differences, prove that

$$\sum_{r=2}^n \frac{2}{(r-1)(r+1)} = \frac{3}{2} - \frac{2n+1}{n(n+1)}.$$

[AEB January 1998]

9. The function  $f$  is defined for all non-negative integers  $r$  by

$$f(r) = r^2 + r - 1.$$

(a) Verify that  $f(r) - f(r-1) = Ar$  for some integer  $A$ , stating the value of  $A$ .

(b) Hence, using the method of differences, prove that

$$\sum_{r=1}^n r = \frac{1}{2}(n^2 + n).$$

[AEB January 2000]

10. For some value of the constant  $A$ ,

$$\sum_{r=1}^n \frac{3r-2}{r(r+1)(r+2)} = A - \frac{3n+2}{(n+1)(n+2)}.$$

(a) By setting  $n = 1$ , or otherwise, determine the value of  $A$ .

(b) Use mathematical induction to prove the result for all positive integers  $n$ .

(c) Deduce the sum of the infinite series

$$\frac{1}{1 \times 2 \times 3} + \frac{4}{2 \times 3 \times 4} + \frac{7}{3 \times 4 \times 5} + \dots + \frac{3n-2}{n(n+1)(n+2)} + \dots.$$

[AEB June 2000]

## Chapter 4: De Moivre's Theorem and its Applications

- 4.1 De Moivre's theorem
- 4.2 Using de Moivre's theorem to evaluate powers of complex numbers
- 4.3 Application of de Moivre's theorem in establishing trigonometric identities
- 4.4 Exponential form of a complex number
- 4.5 The cube roots of unity
- 4.6 The  $n$ th roots of unity
- 4.7 The roots of  $z^n = \alpha$ , where  $\alpha$  is a non-real number

---

This chapter introduces de Moivre's theorem and many of its applications. When you have completed it, you will:

- know the basic theorem;
- be able to find shorter ways of working out powers of complex numbers;
- discover alternative methods for establishing some trigonometric identities;
- know a new way of expressing complex numbers;
- know how to work out the  $n$ th roots of unity and, in particular, the cube roots;
- be able to solve certain types of polynomial equations.

## 4.1 De Moivre's theorem

In Chapter 3 (section 3.4), you saw a very important result known as de Moivre's theorem. It was proved by induction that, if  $n$  is a positive integer, then

$$(\cos \theta + i \sin \theta)^n = \cos n\theta + i \sin n\theta.$$

De Moivre's theorem holds not only when  $n$  is a positive integer, but also when it is negative and even when it is fractional.

Let  $n$  be a negative integer and suppose  $n = -k$ . Then  $k$  is a positive integer and

$$\begin{aligned} (\cos \theta + i \sin \theta)^n &= (\cos \theta + i \sin \theta)^{-k} \\ &= \frac{1}{(\cos \theta + i \sin \theta)^k} \\ &= \frac{1}{\cos k\theta + i \sin k\theta}. \end{aligned}$$

Some of the results obtained in Chapter 1 can now be put to use. In order to remove  $i$  from the denominator of the expression above, the numerator and denominator are multiplied by the complex conjugate of the denominator, in this case  $\cos k\theta - i \sin k\theta$ . Thus,

$$\begin{aligned} \frac{1}{\cos k\theta + i \sin k\theta} &= \frac{1}{\cos k\theta + i \sin k\theta} \times \frac{\cos k\theta - i \sin k\theta}{\cos k\theta - i \sin k\theta} \\ &= \frac{\cos k\theta - i \sin k\theta}{\cos^2 k\theta + i \sin k\theta \cos k\theta - i \sin k\theta \cos k\theta - i^2 \sin^2 k\theta} \\ &= \frac{\cos k\theta - i \sin k\theta}{\cos^2 k\theta + \sin^2 k\theta} \\ &= \cos k\theta - i \sin k\theta \\ &= \cos(-k\theta) + i \sin(-k\theta) \\ &= \cos n\theta + i \sin n\theta, \quad \text{as required.} \end{aligned}$$

If  $n$  is a fraction, say  $\frac{p}{q}$  where  $p$  and  $q$  are integers, then

$$\begin{aligned} \left( \cos \frac{p}{q}\theta + i \sin \frac{p}{q}\theta \right)^q &= \cos \frac{p\theta}{q} + i \sin \frac{p\theta}{q} \quad [q \text{ is an integer}] \\ &= \cos p\theta + i \sin p\theta. \end{aligned}$$

But  $p$  is also an integer and so

$$\cos p\theta + i \sin p\theta = (\cos \theta + i \sin \theta)^p.$$

Taking the  $q^{\text{th}}$  root of both sides,

$$\cos \frac{p}{q}\theta + i \sin \frac{p}{q}\theta = (\cos \theta + i \sin \theta)^{\frac{p}{q}}.$$

It is important to point out at this stage that  $\cos \frac{p}{q} \theta + i \sin \frac{p}{q} \theta$  is just one value of  $(\cos \theta + i \sin \theta)^{\frac{p}{q}}$ . A simple example will illustrate this. If  $\theta = \pi$ ,  $p = 1$  and  $q = 2$ , then

$$\begin{aligned}(\cos \pi + i \sin \pi)^{\frac{1}{2}} &= \cos \frac{1}{2} \pi + i \sin \frac{1}{2} \pi \\ &= i.\end{aligned}$$

But  $(\cos \pi + i \sin \pi)^{\frac{1}{2}} = \sqrt{-1}$  ( $\cos \pi = -1$  and  $\sin \pi = 0$ ) and  $\sqrt{-1} = \pm i$ . So  $i$  is only one value of  $(\cos \pi + i \sin \pi)^{\frac{1}{2}}$ . There are, in fact,  $q$  different values of  $(\cos \pi + i \sin \pi)^{\frac{p}{q}}$  and this will be shown in section 4.6.

$$(\cos \theta + i \sin \theta)^n = \cos n\theta + i \sin n\theta$$

for positive and negative integers, and fractional values of  $n$

## 4.2 Using de Moivre's theorem to evaluate powers of complex numbers

One very important application of de Moivre's theorem is in the addition of complex numbers of the form  $(a + ib)^n$ . The method for doing this will be illustrated through examples.

### Example 4.2.1

Simplify  $\left(\cos \frac{\pi}{6} + i \sin \frac{\pi}{6}\right)^3$ .

#### **Solution**

It would, of course, be possible to multiply  $\cos \frac{\pi}{6} + i \sin \frac{\pi}{6}$  by itself three times, but this would be laborious and time consuming – even more so had the power been greater than 3. Instead,

$$\begin{aligned}\left(\cos \frac{\pi}{6} + i \sin \frac{\pi}{6}\right)^3 &= \cos \frac{3\pi}{6} + i \sin \frac{3\pi}{6} \\ &= \cos \frac{\pi}{2} + i \sin \frac{\pi}{2} \\ &= 0 + i \\ &= i.\end{aligned}$$



**Example 4.2.2**

Find  $(\sqrt{3} + i)^{10}$  in the form  $a + ib$ .

**Solution**

Clearly it would not be practical to multiply  $(\sqrt{3} + i)$  by itself ten times. De Moivre's theorem could provide an alternative method but it can be used only for complex numbers in the form  $\cos \theta + i \sin \theta$ , and  $\sqrt{3} + i$  is not in this form. A technique introduced in Chapter 1 (section 1.4) can be used to express it in polar form.#

On an Argand diagram,  $\sqrt{3} + i$  is represented by the point whose Cartesian coordinates are  $(\sqrt{3}, 1)$ .

Now,  $r = \sqrt{(\sqrt{3})^2 + 1^2} = 2$  and  $\tan \theta = \frac{1}{\sqrt{3}}$  so that  $\theta = \frac{\pi}{6}$ .

Thus,  $\sqrt{3} + i = 2 \left( \cos \frac{\pi}{6} + i \sin \frac{\pi}{6} \right)$

$$\begin{aligned} \text{and } (\sqrt{3} + i)^{10} &= 2^{10} \left( \cos \frac{\pi}{6} + i \sin \frac{\pi}{6} \right)^{10} \\ &= 2^{10} \left( \cos \frac{10\pi}{6} + i \sin \frac{10\pi}{6} \right) \\ &= 1024 \left( \frac{1}{2} - \frac{i\sqrt{3}}{2} \right) \\ &= 512(1 - i\sqrt{3}). \end{aligned}$$

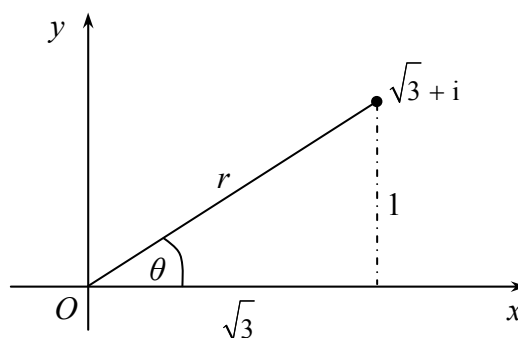

[note that 2 is raised to the power 10 as well]

**Example 4.2.3**

Simplify  $\left(\cos \frac{\pi}{6} - i \sin \frac{\pi}{6}\right)^3$ .

**Solution**

De Moivre's theorem applies only to expressions in the form  $\cos \theta + i \sin \theta$  and not  $\cos \theta - i \sin \theta$ , so the expression to be simplified must be written in the form

$\cos\left(-\frac{\pi}{6}\right) + i \sin\left(-\frac{\pi}{6}\right)$ .

$$\begin{aligned}\left(\cos \frac{\pi}{6} - i \sin \frac{\pi}{6}\right)^3 &= \left[\cos\left(-\frac{\pi}{6}\right) + i \sin\left(-\frac{\pi}{6}\right)\right]^3 \\ &= \cos\left(-\frac{3\pi}{6}\right) + i \sin\left(-\frac{3\pi}{6}\right) \\ &= \cos\left(-\frac{\pi}{2}\right) + i \sin\left(-\frac{\pi}{2}\right) \\ &= \cos \frac{\pi}{2} - i \sin \frac{\pi}{2} \\ &= -i.\end{aligned}$$

Note that it is apparent from this example that  $(\cos \theta - i \sin \theta)^n = \cos n\theta - i \sin n\theta$ . It is very important to realise that this is a **deduction from** de Moivre's theorem and it must not be quoted **as** the theorem.

**Example 4.2.4**

Find  $\frac{1}{(-2+2\sqrt{3}i)^3}$  in the form  $a+ib$ .

**Solution**

The complex number  $-2+2\sqrt{3}i$  is represented by the point whose Cartesian coordinates are  $(-2, 2\sqrt{3})$  on the Argand diagram shown here.

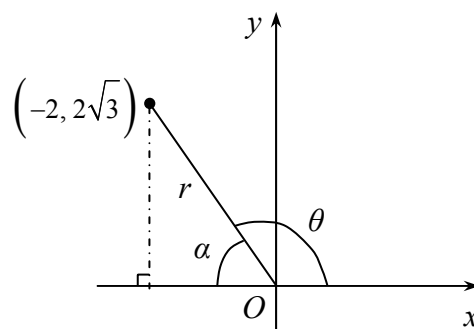

Hence,  $r = \sqrt{(-2)^2 + (2\sqrt{3})^2} = \sqrt{16} = 4$ , and  $\tan \theta = -\tan \alpha = -\frac{2\sqrt{3}}{2}$  so that  $\theta = \frac{2\pi}{3}$ . Thus

$$\begin{aligned} \frac{1}{(-2+2\sqrt{3}i)^3} &= (-2+2\sqrt{3}i)^{-3} \\ &= \left[ 4 \left( \cos \frac{2\pi}{3} + i \sin \frac{2\pi}{3} \right) \right]^{-3} \\ &= 4^{-3} \left[ \cos \left( -3 \times \frac{2\pi}{3} \right) + i \sin \left( -3 \times \frac{2\pi}{3} \right) \right] \\ &= \frac{1}{64} \left[ \cos(-2\pi) + i \sin(-2\pi) \right] \\ &= \frac{1}{64} (1+0) \\ &= \frac{1}{64}. \end{aligned}$$

**Exercise 4A**

1. Prove that  $(\cos \theta - i \sin \theta)^n = \cos n\theta - i \sin n\theta$ .

2. Express each of the following in the form  $a+ib$ :

- |   |   |  |
|---|---|--|
| (a) $(\cos 3\theta + i \sin 3\theta)^5$ | (b) $\left( \cos \frac{\pi}{5} + i \sin \frac{\pi}{5} \right)^{10}$ | (c) $\left( \cos \frac{\pi}{4} + i \sin \frac{\pi}{4} \right)^2$ |
| (d) $(1+i)^6$                           | (e) $(2-2i)^4$  | (f) $\frac{1}{(1+\sqrt{3}i)^5}$                                  |
| (g) $(\sqrt{3}+3i)^9$                   |   |  |

### 4.3 Application of de Moivre's theorem in establishing trigonometric identities

One way of showing how these identities can be derived is to use examples. The same principles are used whichever identity is required.

#### Example 4.3.1

Show that  $\cos 3\theta = 4\cos^3 \theta - 3\cos \theta$ .

#### Solution

There are several ways of establishing this result. The expansion of  $\cos(A+B)$  can be used to express  $\cos 2\theta$  in terms of  $\cos \theta$  setting  $A = \theta$  and  $B = \theta$ . Similarly, the expansion of  $\cos(2\theta + \theta)$  can be used to give  $\cos 3\theta$  in terms of  $\cos \theta$ . Using de Moivre's theorem gives a straightforward alternative method.

$$\begin{aligned} \cos 3\theta + i \sin 3\theta &= (\cos \theta + i \sin \theta)^3 \\ &= \cos^3 \theta + 3\cos^2 \theta(i \sin \theta) + 3\cos \theta(i \sin \theta)^2 + (i \sin \theta)^3 \\ &\quad \left[ \text{using the binomial expansion of } (p+q)^3 \right] \\ &= \cos^3 \theta + 3i \cos^2 \theta \sin \theta - 3\cos \theta \sin^2 \theta - i \sin^3 \theta \\ &\quad \left[ \text{using } i^2 = -1 \right]. \end{aligned}$$

Now  $\cos 3\theta$  is the **real** part of the left-hand side of the equation, and the real parts of both sides can be equated,

$$\begin{aligned} \cos 3\theta &= \cos^3 \theta - 3\cos \theta \sin^2 \theta \\ &= \cos^3 \theta - 3\cos \theta (1 - \cos^2 \theta) \quad \left[ \text{since } \cos^2 \theta + \sin^2 \theta = 1 \right] \\ &= 4\cos^3 \theta - 3\cos \theta. \end{aligned}$$

Note that this equation will also give  $\sin 3\theta$  by equating the **imaginary** parts of both sides of the equation.

**Example 4.3.2**

Express  $\tan 4\theta$  in terms of  $\tan \theta$ .

**Solution**

$\tan 4\theta = \frac{\sin 4\theta}{\cos 4\theta}$  so expressions for  $\sin 4\theta$  and  $\cos 4\theta$  in terms of  $\sin \theta$  and  $\cos \theta$  must be established to start with. Using de Moivre's theorem,

$$\begin{aligned} \cos 4\theta + i \sin 4\theta &= (\cos \theta + i \sin \theta)^4 \\ &= \cos^4 \theta + 4 \cos^3 \theta (i \sin \theta) + 6 \cos^2 \theta (i \sin \theta)^2 + 4 \cos \theta (i \sin \theta)^3 + (i \sin \theta)^4 \\ &\quad \text{[using the binomial expansion]} \\ &= \cos^4 \theta + 4i \cos^3 \theta \sin \theta - 6 \cos^2 \theta \sin^2 \theta - 4i \cos \theta \sin^3 \theta + \sin^4 \theta \\ &\quad \text{[using } i^2 = -1 \text{]} \end{aligned}$$

Equating the real parts on both sides of the equation,

$$\cos 4\theta = \cos^4 \theta - 6 \cos^2 \theta \sin^2 \theta + \sin^4 \theta,$$

and equating the imaginary parts,

$$\sin 4\theta = 4 \cos^3 \theta \sin \theta - 4 \cos \theta \sin^3 \theta.$$

Now,

$$\begin{aligned} \tan 4\theta &= \frac{\sin 4\theta}{\cos 4\theta} \\ &= \frac{4 \cos^3 \theta \sin \theta - 4 \cos \theta \sin^3 \theta}{\cos^4 \theta - 6 \cos^2 \theta \sin^2 \theta + \sin^4 \theta}. \end{aligned}$$

Dividing every term by  $\cos^4 \theta$  gives

$$\tan 4\theta = \frac{4 \frac{\sin \theta}{\cos \theta} - 4 \frac{\sin^3 \theta}{\cos^3 \theta}}{1 - 6 \frac{\sin^2 \theta}{\cos^2 \theta} + \frac{\sin^4 \theta}{\cos^4 \theta}}.$$

But  $\tan \theta = \frac{\sin \theta}{\cos \theta}$  so

$$\tan 4\theta = \frac{4 \tan \theta - 4 \tan^3 \theta}{1 - 6 \tan^2 \theta + \tan^4 \theta}.$$

**Exercise 4B**

1. Express  $\sin 3\theta$  in terms of  $\sin \theta$ .
2. Express  $\tan 3\theta$  in terms of  $\tan \theta$ .
3. Express  $\sin 5\theta$  in terms of  $\sin \theta$ .
4. Show that  $\cos 6\theta = \cos^6 \theta - 3\cos^4 \theta + 3\cos^2 \theta - 1$ .

So far  $\sin n\theta$ ,  $\cos n\theta$  and  $\tan n\theta$  have been expressed in terms of  $\sin \theta$ ,  $\cos \theta$  and  $\tan \theta$ . De Moivre's theorem can be used to express powers of  $\sin \theta$ ,  $\cos \theta$  and  $\tan \theta$  in terms of sines, cosines and tangents of multiple angles. First some important results must be established.

Suppose  $z = \cos \theta + i \sin \theta$ . Then

$$\begin{aligned} z^{-1} &= \frac{1}{z} = (\cos \theta + i \sin \theta)^{-1} \\ &= \cos(-\theta) + i \sin(-\theta) \\ &= \cos \theta - i \sin \theta \quad (= z). \end{aligned}$$

So,

$$z = \cos \theta + i \sin \theta$$

$$\frac{1}{z} = \cos \theta + i \sin \theta.$$

Adding,

$$z + \frac{1}{z} = 2 \cos \theta,$$

and subtracting,

$$z - \frac{1}{z} = 2i \sin \theta.$$

$$\begin{aligned} \text{If } z &= \cos \theta + i \sin \theta \\ z + \frac{1}{z} &= 2 \cos \theta \\ z - \frac{1}{z} &= 2i \sin \theta \end{aligned}$$

Also,

$$z^n = (\cos \theta + i \sin \theta)^n = \cos n\theta + i \sin n\theta$$

$$\begin{aligned} z^{-n} &= \frac{1}{z^n} = (\cos \theta + i \sin \theta)^{-n} \\ &= \cos(-n\theta) + i \sin(-n\theta) \\ &= \cos n\theta - i \sin n\theta. \end{aligned}$$

Combining  $z^n$  and  $\frac{1}{z^n}$  as before,

$$z^n + \frac{1}{z^n} = 2 \cos n\theta,$$

$$z^n - \frac{1}{z^n} = 2i \sin n\theta.$$

$$\begin{aligned} \text{If } z &= \cos \theta + i \sin \theta, \\ z^n + \frac{1}{z^n} &= 2 \cos n\theta \\ z^n - \frac{1}{z^n} &= 2i \sin n\theta \end{aligned}$$

A common mistake is to omit the  $i$  in  $2i \sin n\theta$ , so make a point of remembering this result carefully.

**Example 4.3.3**

Show that  $\cos^5 \theta = \frac{1}{16}(\cos 5\theta + 5 \cos 3\theta + 10 \cos \theta)$ .

**Solution**

Suppose  $z = \cos \theta + i \sin \theta$ .

Then  $z + \frac{1}{z} = 2 \cos \theta$

and  $(2 \cos \theta)^5 = \left(z + \frac{1}{z}\right)^5$

$$= z^5 + 5z^4\left(\frac{1}{z}\right) + 10z^3\left(\frac{1}{z}\right)^2 + 10z^2\left(\frac{1}{z}\right)^3 + 5z\left(\frac{1}{z}\right)^4 + \left(\frac{1}{z}\right)^5$$

$$= z^5 + 5z^3 + 10z + 10\left(\frac{1}{z}\right) + 5\left(\frac{1}{z}\right)^3 + \left(\frac{1}{z}\right)^5.$$

So  $32 \cos^5 \theta = \left[z^5 + \left(\frac{1}{z}\right)^5\right] + \left[5z^3 + 5\left(\frac{1}{z}\right)^3\right] + \left[10z + 10\left(\frac{1}{z}\right)\right]$

$$= \left[z^5 + \left(\frac{1}{z}\right)^5\right] + 5\left[z^3 + \left(\frac{1}{z}\right)^3\right] + 10\left[z + \left(\frac{1}{z}\right)\right].$$

Using the results established earlier,

$$z^5 + \frac{1}{z^5} = 2 \cos 5\theta,$$

$$z^3 + \frac{1}{z^3} = 2 \cos 3\theta,$$

$$z + \frac{1}{z} = 2 \cos \theta.$$

Hence  $32 \cos^5 \theta = 2 \cos 5\theta + 5(2 \cos 3\theta) + 10(2 \cos \theta)$

$$\cos^5 \theta = \frac{1}{16}(\cos 5\theta + 5 \cos 3\theta + 10 \cos \theta), \quad \text{as required.}$$

One very useful application of the example above would be in integrating  $\cos^5 \theta$ .

$$\int \cos^5 \theta = \int \frac{1}{16}(\cos 5\theta + 5 \cos 3\theta + 10 \cos \theta)$$

$$= \frac{1}{16} \left[ \left( \frac{\sin 5\theta}{5} + \frac{5 \sin 3\theta}{3} + 10 \sin \theta \right) \right] + c, \quad \text{where } c \text{ is an arbitrary constant.}$$

**Example 4.3.4**

(a) Show that  $\cos^3 \theta \sin^3 \theta = \frac{1}{32}(3 \sin 2\theta - \sin 6\theta)$

(b) Evaluate  $\int_0^{\frac{\pi}{2}} \cos^3 \theta \sin^3 \theta \, d\theta$ .



**Solution**

$$\begin{aligned} \text{(a)} \quad (2 \cos \theta)^3 &= \left(z + \frac{1}{z}\right)^3 \\ (2 \sin \theta)^3 &= \left(z - \frac{1}{z}\right)^3. \end{aligned}$$

Multiplying these,

$$\begin{aligned} 8 \cos^3 \theta \sin^3 \theta &= \left(z + \frac{1}{z}\right)^3 \left(z - \frac{1}{z}\right)^3 \\ -64i \cos^3 \theta \sin^3 \theta &= \left[\left(z + \frac{1}{z}\right)\left(z - \frac{1}{z}\right)\right]^3 \\ &= \left(z^2 - \frac{1}{z^2}\right)^3 \\ &= (z^2)^3 - 3(z^2)^2\left(\frac{1}{z^2}\right) + 3(z^2)\left(\frac{1}{z^2}\right)^2 - \left(\frac{1}{z^2}\right)^3 \\ &= z^6 - 3z^2 + 3\left(\frac{1}{z^2}\right) - \frac{1}{z^6} \\ &= \left(z^6 - \frac{1}{z^6}\right) - 3\left(z^2 - \frac{1}{z^2}\right). \end{aligned}$$

$$\text{Now } z^6 - \frac{1}{z^6} = 2i \sin 6\theta \quad \text{and} \quad z^2 - \frac{1}{z^2} = 2i \sin 2\theta.$$

$$\begin{aligned} \text{Thus,} \quad -64i \cos^3 \theta \sin^3 \theta &= 2i \sin 6\theta - 3(2i \sin 2\theta) \\ &= 2i \sin 6\theta - 6i \sin 2\theta. \end{aligned}$$

Dividing both sides by  $-64i$ ,

$$\begin{aligned} \cos^3 \theta \sin^3 \theta &= -\frac{1}{32} \sin 6\theta + \frac{3}{32} \sin 2\theta \\ &= \frac{1}{32} (3 \sin 2\theta - \sin 6\theta), \quad \text{as required.} \end{aligned}$$

$$\begin{aligned} \text{(b)} \quad \int_0^{\frac{\pi}{2}} \cos^3 \theta \sin^3 \theta \, d\theta &= \frac{1}{32} \int_0^{\frac{\pi}{2}} (3 \sin 2\theta - \sin 6\theta) \, d\theta \\ &= \frac{1}{32} \left[ -\frac{3 \cos 2\theta}{2} + \frac{\cos 6\theta}{6} \right]_0^{\frac{\pi}{2}} \\ &= \frac{1}{32} \left[ \frac{3}{2} - \frac{1}{6} - \left(-\frac{3}{2} + \frac{1}{6}\right) \right] \\ &= \frac{1}{32} \times \frac{8}{3} = \frac{1}{12}. \end{aligned}$$

This section concludes with an example which uses the ideas introduced here and extends into other areas of mathematics.

**Example 4.3.5**

- (a) Show that  $\cos 5\theta = \cos \theta (16 \cos^4 \theta - 20 \cos^2 \theta + 5)$ .
- (b) Show that the roots of the equation  $16x^4 - 20x + 5 = 0$  are  $\cos \frac{r\pi}{10}$  for  $r = 1, 3, 7$  and  $9$ .
- (c) Deduce that  $\cos^2 \frac{\pi}{10} \cos^2 \frac{3\pi}{10} = \frac{5}{16}$ .

**Solution**

(a) Using the ideas introduced at the beginning of this section,

$$\cos 5\theta + i \sin 5\theta = (\cos \theta + i \sin \theta)^5.$$

Using the binomial theorem for expansion, the right-hand side of this equation becomes

$$\cos^5 \theta + 5 \cos^4 \theta (i \sin \theta) + 10 \cos^3 \theta (i \sin \theta)^2 + 10 \cos^2 \theta (i \sin \theta)^3 + 5 \cos \theta (i \sin \theta)^4 + (i \sin \theta)^5.$$

Not every term of this expression has to be simplified. As  $\cos 5\theta$  is the real part of the left-hand side of the equation, it equates to the real part of the right-hand side. The real part of the right-hand side of the equation comprises those terms with even powers of  $i$  in them, since  $i^2 = -1$  and is real.

$$\begin{aligned} \text{Thus, } \cos 5\theta &= \cos^5 \theta + 10 \cos^3 \theta (i \sin \theta)^2 + 5 \cos \theta (i \sin \theta)^4 \\ &= \cos^5 \theta + 10 \cos^3 \theta (-\sin^2 \theta) + 5 \cos \theta \sin^4 \theta \\ &= \cos^5 \theta + 10 \cos^3 \theta (-1 + \cos^2 \theta) + 5 \cos \theta (1 - \cos^2 \theta)^2 \quad \text{using } \cos^2 \theta + \sin^2 \theta = 1 \\ &= \cos^5 \theta - 10 \cos^3 \theta + 10 \cos^5 \theta + 5 \cos \theta - 10 \cos^3 \theta + 5 \cos^5 \theta \\ &= 16 \cos^5 \theta - 20 \cos^3 \theta + 5 \cos \theta \\ &= \cos \theta (16 \cos^4 \theta - 20 \cos^2 \theta + 5). \end{aligned}$$

- (b) Now when  $\cos 5\theta = 0$ , either  $\cos \theta = 0$  or  $16\cos^4 \theta - 20\cos^2 \theta + 5 = 0$ . So, putting  $x = \cos \theta$ , the roots of  $16x^4 - 20x + 5 = 0$  are the values of  $\cos \theta$  for which  $\cos 5\theta = 0$ , provided  $\cos \theta \neq 0$ .

$$\text{But if } \cos 5\theta = 0, \quad 5\theta = \frac{\pi}{2}, \frac{3\pi}{2}, \frac{5\pi}{2}, \frac{7\pi}{2}, \frac{9\pi}{2}, \frac{11\pi}{2}, \frac{13\pi}{2}, \dots$$

$$\text{so that} \quad \theta = \frac{\pi}{10}, \frac{3\pi}{10}, \frac{5\pi}{10}, \frac{7\pi}{10}, \frac{9\pi}{10}, \frac{11\pi}{10}, \frac{13\pi}{10}, \dots$$

Also,  $\cos \frac{11\pi}{10}$  is the same as  $\cos \frac{9\pi}{10}$ , and  $\cos \frac{13\pi}{10}$  is the same as  $\cos \frac{7\pi}{10}$ , so that, although there is an infinite number of values of  $\theta$ , there are only five **distinct** values of  $\cos \theta$  and these are  $\cos \frac{\pi}{10}$ ,  $\cos \frac{3\pi}{10}$ ,  $\cos \frac{5\pi}{10}$ ,  $\cos \frac{7\pi}{10}$  and  $\cos \frac{9\pi}{10}$ .

Now  $\cos \frac{5\pi}{10} = \cos \frac{\pi}{2} = 0$  and  $\frac{\pi}{2}$  is, of course, a root of  $\cos \theta = 0$ , so that the roots of the equation  $16x^4 - 20x + 5 = 0$  are  $\cos \frac{\pi}{10}$ ,  $\cos \frac{3\pi}{10}$ ,  $\cos \frac{5\pi}{10}$ ,  $\cos \frac{7\pi}{10}$  and  $\cos \frac{9\pi}{10}$ .

The roots may be written in a slightly different way as

$$\begin{aligned} \cos \frac{7\pi}{10} &= \cos \left( \pi - \frac{3\pi}{10} \right) \\ &= -\cos \frac{3\pi}{10}, \end{aligned}$$

and

$$\begin{aligned} \cos \frac{9\pi}{10} &= \cos \left( \pi - \frac{\pi}{10} \right) \\ &= -\cos \frac{\pi}{10}. \end{aligned}$$

Thus the four roots of the quartic equation  $16x^4 - 20x + 5 = 0$  can be written as  $\pm \cos \frac{\pi}{10}$  and  $\pm \cos \frac{3\pi}{10}$ .

- (c) From the ideas set out in Chapter 2 (section 2.7), the product of the roots of the quartic equation  $16x^4 - 20x + 5 = 0$  is  $\frac{5}{16}$  so that

$$\cos \frac{\pi}{10} \left( -\cos \frac{\pi}{10} \right) \cos \frac{3\pi}{10} \left( -\cos \frac{3\pi}{10} \right) = \frac{5}{16}.$$

And hence, 
$$\cos^2 \frac{\pi}{10} \cos^2 \frac{3\pi}{10} = \frac{5}{16}.$$

**Exercise 4C**

1. If  $z = \cos \theta + i \sin \theta$  write, in terms of  $z$ :

(a)  $\cos 4\theta$       (b)  $\cos 7\theta$       (c)  $\sin 6\theta$       (d)  $\sin 3\theta$

2. Prove the following results:

(a)  $\cos 4\theta = 8\cos^4 \theta - 8\cos^2 \theta + 1$

(b)  $\sin 5\theta = 16\sin^5 \theta - 20\sin^3 \theta + 5\sin \theta$

(c)  $\sin 6\theta = \sin \theta (32\cos^5 \theta - 32\cos^3 \theta + 6\cos \theta)$

(d)  $\tan 3\theta = \frac{3\tan \theta - \tan^3 \theta}{1 - 3\tan^2 \theta}$

### 4.4 Exponential form of a complex number

Both  $\cos \theta$  and  $\sin \theta$  can be expressed as an infinite series in powers of  $\theta$ , provided that  $\theta$  is measured in radians. These are given by

$$\cos \theta = \theta - \frac{\theta^2}{2!} + \frac{\theta^4}{4!} - \frac{\theta^6}{6!} + \dots (-1)^{n-1} \frac{\theta^{2n-2}}{(2n-2)!} + \dots$$

and

$$\sin \theta = \theta - \frac{\theta^3}{3!} + \frac{\theta^5}{5!} - \frac{\theta^7}{7!} + \dots (-1)^{n-1} \frac{\theta^{2n-1}}{(2n-1)!} + \dots$$

There is also a series for  $e^x$  given by

$$e^x = 1 + x + \frac{x^2}{2!} + \frac{x^3}{3!} + \frac{x^4}{4!} + \dots + \frac{x^{n-1}}{(n-1)!} + \dots$$

If  $i\theta$  is substituted for  $x$  in the series for  $e^x$ ,

$$\begin{aligned} e^{i\theta} &= 1 + i\theta + \frac{(i\theta)^2}{2!} + \frac{(i\theta)^3}{3!} + \frac{(i\theta)^4}{4!} + \dots + \frac{(i\theta)^{n-1}}{(n-1)!} + \dots \\ &= 1 + i\theta - \frac{\theta^2}{2!} - \frac{i\theta^3}{3!} + \frac{\theta^4}{4!} + \dots \end{aligned}$$

Regrouping,

$$e^{i\theta} = 1 - \frac{\theta^2}{2!} + \frac{\theta^4}{4!} - \dots + i \left( \theta - \frac{\theta^3}{3!} + \dots \right),$$

and, using the previous results for  $\sin \theta$  and  $\cos \theta$ ,

$$e^{i\theta} = \cos \theta + i \sin \theta.$$

It is also important to note that if  $z = \cos \theta + i \sin \theta$ , then

$$\begin{aligned} z^n &= (\cos \theta + i \sin \theta)^n \\ &= \cos n\theta + i \sin n\theta \\ &= e^{ni\theta}, \end{aligned}$$

and if  $z = r(\cos \theta + i \sin \theta)$ , then  $z = re^{i\theta}$  and  $z^n = r^n e^{ni\theta}$ .

If  $z = r(\cos \theta + i \sin \theta)$ ,  
then  $z = re^{i\theta}$   
and  $z^n = r^n e^{ni\theta}$

The form  $re^{i\theta}$  is known as the exponential form of a complex number and is clearly linked to the polar form very closely.

Another result can be derived from the exponential form of a complex number:

$$e^{i\theta} = \cos \theta + i \sin \theta.$$

So, 
$$e^{-i\theta} = \cos(-\theta) + i \sin(-\theta) \\ = \cos \theta - i \sin \theta.$$

Adding these

$$e^{i\theta} + e^{-i\theta} = (\cos \theta + i \sin \theta) + (\cos \theta - i \sin \theta) \\ = 2 \cos \theta,$$

or 
$$\cos \theta = \frac{e^{i\theta} + e^{-i\theta}}{2}.$$

Subtracting gives 
$$e^{i\theta} - e^{-i\theta} = (\cos \theta + i \sin \theta) - (\cos \theta - i \sin \theta) \\ = 2i \sin \theta,$$

or 
$$\sin \theta = \frac{e^{i\theta} - e^{-i\theta}}{2i}.$$

$$\cos \theta = \frac{e^{i\theta} + e^{-i\theta}}{2}$$

$$\sin \theta = \frac{e^{i\theta} - e^{-i\theta}}{2i}$$

### Example 4.4.1

Express  $2 - 2i$  in the form  $re^{i\theta}$ .

**Solution**

The complex number  $2 - 2i$  is represented by the point with the coordinates  $(2, -2)$  on an Argand diagram.

Hence, 
$$r = \sqrt{2^2 + (-2)^2} = \sqrt{8},$$

and 
$$\theta = -\tan^{-1} \frac{2}{2} = -\frac{\pi}{4},$$

so that 
$$2 - 2i = \sqrt{8} e^{-\frac{\pi i}{4}}.$$

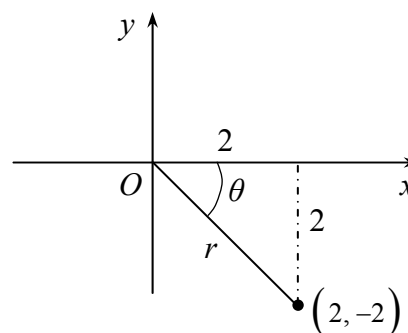

### Exercise 4D

1. Express the following in the form  $re^{i\theta}$  :

- (a)  $1 + i$       (b)  $\sqrt{3} - i$       (c)  $3 + \sqrt{3}i$       (d)  $-2\sqrt{3} + 2i$

## 4.5 The cube roots of unity

The cube roots of 1 are numbers such that when they are cubed their value is 1. They must, therefore, satisfy the equation  $z^3 - 1 = 0$ . Clearly, one root of  $z^3 - 1$  is  $z = 1$  so that  $z - 1$  must be a factor of  $z^3 - 1$ . Factorising,

$$z^3 - 1 = (z - 1)(z^2 + z + 1) = 0.$$

Now  $z^3 - 1 = 0$  is a cubic equation and so has three roots, one of which is  $z = 1$ . The other two come from the quadratic equation  $z^2 + z + 1 = 0$ . If one of these is denoted by  $w$ , then  $w$  satisfies  $z^2 + z + 1 = 0$  so that  $w^2 + w + 1 = 0$ . It can also be shown that if  $w$  is a root of  $z^3 = 1$ , then  $w^2$  is also a root – in fact, the other root. Substituting  $w^2$  into the left-hand side of  $z^3 = 1$  gives  $(w^2)^3 = w^6 = (w^3)^2 = 1^2 = 1$ , as  $w^3 = 1$  since  $w$  is a solution of  $z^3 = 1$ .

Thus the three cube roots of 1 are 1,  $w$  and  $w^2$ , where  $w$  and  $w^2$  are non-real. Of course,  $w$  can be expressed in the form  $a + ib$  by solving  $z^2 + z + 1 = 0$  using the quadratic formula:

$$\begin{aligned} z &= \frac{-1 \pm \sqrt{1^2 - (4 \times 1 \times 1)}}{2} \\ &= \frac{-1 \pm \sqrt{-3}}{2} \\ &= \frac{-1 \pm i\sqrt{3}}{2}. \end{aligned}$$

It doesn't matter whether  $w$  is labelled as  $\frac{-1 + i\sqrt{3}}{2}$  or as  $\frac{-1 - i\sqrt{3}}{2}$  because each is the square of the other. In other words, if  $w = \frac{-1 + i\sqrt{3}}{2}$  then

$$\begin{aligned} w^2 &= \left( \frac{-1 + i\sqrt{3}}{2} \right)^2 \\ &= \frac{1 - 2i\sqrt{3} + (i\sqrt{3})^2}{4} \\ &= \frac{1 - 2i\sqrt{3} - 3}{4} \\ &= \frac{-2 - 2i\sqrt{3}}{4} \\ &= \frac{-1 - i\sqrt{3}}{2}. \end{aligned}$$

If  $w = \frac{-1 - i\sqrt{3}}{2}$ , then  $w^2 = \frac{-1 + i\sqrt{3}}{2}$ .

The cube roots of unity are 1,  $w$  and  $w^2$ , where

$$w^3 = 1$$

$$1 + w + w^2 = 0$$

and the non-real roots are  $\frac{-1 \pm i\sqrt{3}}{2}$

Both  $w$  and  $w^2$  can be expressed in exponential form. Take  $w = -\frac{1}{2} + \frac{i\sqrt{3}}{2}$ ;  $w$  can be represented by the point whose Cartesian coordinates are  $\left(-\frac{1}{2}, \frac{\sqrt{3}}{2}\right)$  on an Argand diagram.

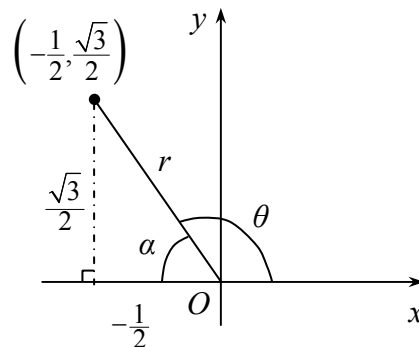

From the diagram,  $r = \sqrt{\left(\frac{\sqrt{3}}{2}\right)^2 + \left(\frac{1}{2}\right)^2} = 1$ , and  $\theta = \pi - \alpha$ , where  $\tan \alpha = \frac{\sqrt{3}/2}{1/2} = \sqrt{3}$ . Thus,

$\alpha = \frac{\pi}{3}$ ,  $\theta = \frac{2\pi}{3}$  and  $w = e^{\frac{2\pi i}{3}}$ . The other root is  $w^2 = \left(e^{\frac{2\pi i}{3}}\right)^2 = e^{\frac{4\pi i}{3}}$  and can also be written as  $e^{-\frac{2\pi i}{3}}$ .

Plotting the three cube roots of unity on an Argand diagram shows three points equally spaced (at intervals of  $\frac{2\pi}{3}$ ) round a circle of radius 1 as shown in the diagram alongside.

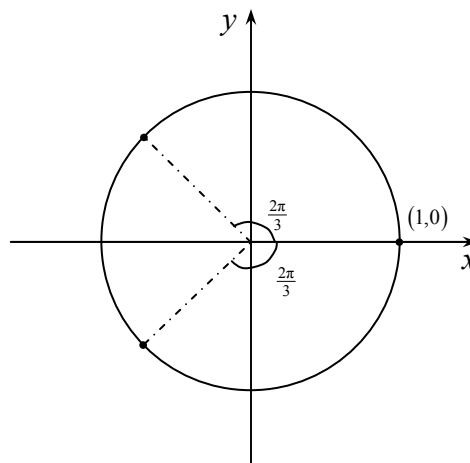

### Example 4.5.1

Simplify  $w^7 + w^8$ , where  $w$  is a complex cube root of 1.

#### Solution

$$w^7 = w^6 \times w = (w^3)^2 \times w = 1^2 \times w = w \quad (\text{because } w^3 = 1),$$

$$w^8 = w^6 \times w^2 = (w^3)^2 \times w^2 = 1^2 \times w^2 = w^2.$$

$$\therefore w^7 + w^8 = w + w^2 = -1 \quad (\text{because } 1 + w + w^2 = 0).$$



**Example 4.5.2**

Show that  $\frac{1}{1+w} + \frac{1}{1+w^2} + \frac{1}{w+w^2} = 0$ .

**Solution**

$1 + w + w^2 = 0$  so  $1 + w = -w^2$ , and so on. So the denominators of the left-hand side of the equation can be replaced to simplify to  $\frac{1}{-w^2} + \frac{1}{-w} + \frac{1}{-1}$ .

Multiplying the first term of this expression by  $w$  in the numerator and denominator, and the second term by  $w^2$  similarly gives

$$\begin{aligned} & \frac{w}{-w^3} + \frac{w^2}{-w^3} - 1 \\ &= -w - w^2 - 1 \quad (\text{as } w^3 = 1) \\ &= 0 \quad (\text{as } 1 + w + w^2 = 0). \end{aligned}$$

**Exercise 4E**

1. If  $w$  is a complex cube root of 1, find the value of

(a)  $w^{10} + w^{11}$       (b)  $(1 + 3w)(1 + 3w^2)$       (c)  $(1 + 3w + w^2)^3$

### 4.6 The $n$ th roots of unity

The equation  $z^n = 1$  clearly has at least one root, namely  $z = 1$ , but it actually has many more, most of which (if not all) are complex. In fact, if  $n$  is odd  $z = 1$  is the only real root, but if  $n$  is even  $z = -1$  is also a real root because  $-1$  raised to an even power is  $+1$ .

To find the remaining roots, the right-hand side of the equation  $z^n = 1$  has to be examined. In exponential form,  $1 = e^0$  because  $e^0 = \cos 0 + i \sin 0 = 1 + i0 = 1$ . But also,  $1 = e^{2\pi i}$  because  $e^{2\pi i} = \cos 2\pi + i \sin 2\pi = 1 + i0 = 1$ . Indeed  $1 = e^{2k\pi i}$  where  $k$  is any integer. Substituting the right-hand side of the equation  $z^n = 1$  by this term gives  $z^n = e^{2k\pi i}$ . Taking the  $n$ th root of both sides gives  $z = e^{\frac{2k\pi i}{n}}$ . Different integer values of  $k$  will give rise to different roots, as shown below.

$$\begin{aligned}
 k = 0 & \text{ gives } e^0 = 1, \\
 k = 1 & \text{ gives } e^{\frac{2\pi i}{n}} = \cos \frac{2\pi}{n} + i \sin \frac{2\pi}{n}, \\
 k = 2 & \text{ gives } e^{\frac{4\pi i}{n}} = \cos \frac{4\pi}{n} + i \sin \frac{4\pi}{n},
 \end{aligned}$$

and so on until

$$k = n - 1 \text{ gives } e^{\frac{2(n-1)\pi i}{n}} = \cos \frac{2(n-1)\pi}{n} + i \sin \frac{2(n-1)\pi}{n}.$$

Thus,  $z = e^{\frac{2k\pi i}{n}}$   $n = 0, 1, 2, \dots, n - 1$  gives the  $n$  distinct roots of the equation  $z^n = 1$ .

There are no more roots because if  $k$  is set equal to  $n$ ,  $e^{\frac{2n\pi i}{n}} = e^{2\pi i} = \cos 2\pi + i \sin 2\pi = 1$ , which is the same root as that given by  $k = 0$ .

Similarly, if  $k$  is set equal to  $n + 1$ ,  $e^{\frac{2(n+1)\pi i}{n}} = e^{\frac{2n\pi i}{n}} \times e^{\frac{2\pi i}{n}} = e^{2\pi i} \times e^{\frac{2\pi i}{n}} = 1 \times e^{\frac{2\pi i}{n}} = e^{\frac{2\pi i}{n}}$  which is the same root as that given by  $k = 1$ , and so on.

The  $n$  roots of  $z^n = 1$  can be illustrated on an Argand diagram. All the roots lie on the circle  $|z| = 1$  because the modulus of every root is 1. Also, the amplitudes of the complex numbers representing the roots are  $\frac{2\pi}{n}, \frac{4\pi}{n}, \frac{6\pi}{n}, \dots, \frac{2(n-1)\pi}{n}$ . In other words, the roots are represented by  $n$  points equally spaced around the unit circle at angles of  $\frac{2\pi}{n}$  starting at  $(1, 0)$  – the point representing the real root  $z = 1$ .

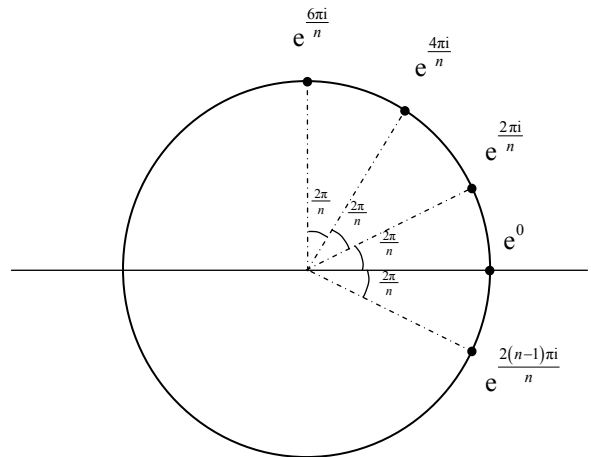

The equation  $z^n = 1$  has roots  $z = e^{\frac{2k\pi i}{n}}$   $k = 0, 1, 2, \dots, (n - 1)$

**Example 4.6.1**

Find, in the form  $a + ib$ , the roots of the equation  $z^6 = 1$  and illustrate these roots on an Argand diagram.

**Solution**

$$z^6 = 1 = e^{2k\pi i}$$

Therefore

$$z = e^{\frac{2k\pi i}{6}} = e^{\frac{k\pi i}{3}} \quad k = 1, 2, 3, 4, 5.$$

Hence the roots are

$$k = 0, \quad z = 1$$

$$k = 1, \quad z = e^{\frac{\pi i}{3}} = \cos \frac{\pi}{3} + i \sin \frac{\pi}{3} = \frac{1}{2} + \frac{i\sqrt{3}}{2}$$

$$k = 2, \quad z = e^{\frac{2\pi i}{3}} = \cos \frac{2\pi}{3} + i \sin \frac{2\pi}{3} = -\frac{1}{2} + \frac{i\sqrt{3}}{2}$$

$$k = 3, \quad z = e^{\pi i} = \cos \pi + i \sin \pi = -1$$

$$k = 4, \quad z = e^{\frac{4\pi i}{3}} = \cos \frac{4\pi}{3} + i \sin \frac{4\pi}{3} = -\frac{1}{2} - \frac{i\sqrt{3}}{2}$$

$$k = 5, \quad z = e^{\frac{5\pi i}{3}} = \cos \frac{5\pi}{3} + i \sin \frac{5\pi}{3} = \frac{1}{2} - \frac{i\sqrt{3}}{2}$$

To summarise, the six roots are

$z = \pm 1, \quad z = \pm \frac{1}{2} \pm \frac{i\sqrt{3}}{2}$  and these are illustrated on the Argand diagram alongside.

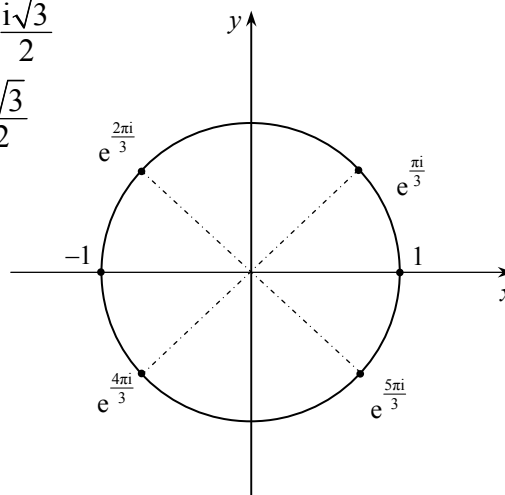

Two further points are worth noting. Firstly, you may need to give the arguments of the roots between  $-\pi$  and  $+\pi$  instead of between  $0$  and  $2\pi$ . In example 4.6.1, the roots would be given as  $z = e^{\frac{k\pi i}{3}}$  for  $k = 0, \pm 1, \pm 2, 3$ . Secondly, a given equation may not involve unity – for example, if example 4.6.1 had concerned  $z^6 = 64$ , the solution would have been written

$$z^6 = 64$$

$$z^6 = 2^6 e^{2k\pi i}$$

$$z = 2e^{\frac{2k\pi i}{6}} \quad k = 0, 1, 2, 3, 4, 5$$

and the only difference would be that the modulus of each root would be 2 instead of 1, with the consequence that the six roots of  $z^6 = 64$  would lie on the circle  $|z| = 2$  instead of  $|z| = 1$ .

Of course, there are variations on the above results. For example, you may need to find the roots of the equation  $1 + z^2 + z^3 + z^4 + z^5 = 0$ . This looks daunting but if you can recognise the left-hand side as a geometric progression with common ratio  $z$ , it becomes more straightforward. Summing the left-hand side of the equation,

$$1 + z^2 + z^3 + z^4 + z^5 = \frac{z^6 - 1}{z^5 - 1} = 0,$$

so that the five roots of  $1 + z^2 + z^3 + z^4 + z^5 = 0$  are five of the roots of  $z^6 - 1 = 0$ . The root to be excluded is the root  $z = 1$  because  $\frac{z^6 - 1}{z^5 - 1}$  is indeterminate when  $z = 1$ . So the roots of

$1 + z^2 + z^3 + z^4 + z^5 = 0$  are  $z = \pm \frac{1}{2} \pm \frac{i\sqrt{3}}{2}$  and  $-1$ , when written in the form  $a + ib$ .

#### Exercise 4F

1. Write, in the form  $a + ib$ , the roots of:

(a)  $z^4 = 1$       (b)  $z^5 = 32$       (c)  $z^{10} = 1$ .

In each case, show the roots on an Argand diagram.

2. Solve the equation  $z^4 + z^3 + z^2 + z + 1 = 0$ .

3. Solve the equation  $1 - 2z + 4z^2 + 8z^3 = 0$ .

4. By considering the roots of  $z^5 = 1$ , show that  $\cos \frac{2\pi}{5} + \cos \frac{4\pi}{5} + \cos \frac{6\pi}{5} + \cos \frac{8\pi}{5} = -1$ .

### 4.7 The roots of $z^n = \alpha$ where $\alpha$ is a non-real number

Every complex number of the form  $a + ib$  can be written in the form  $re^{i\theta}$ , where  $r$  is real and  $\theta$  lies in an interval of  $2\pi$  (usually from 0 to  $2\pi$  or from  $-\pi$  to  $+\pi$ ). Suppose that

$$\alpha = re^{i\theta}.$$

Now 
$$e^{i\theta+2\pi i} = e^{i\theta} \times e^{2\pi i} \quad (\text{using } e^{p+q} = e^p \times e^q)$$

$$= e^{i\theta} \quad (\text{because } e^{2\pi i} = 1).$$

Similarly 
$$e^{i\theta+2k\pi i} = e^{i\theta} \times e^{2k\pi i}$$

$$= e^{i\theta} \quad \text{also.}$$

So, 
$$z^n = \alpha = re^{i\theta+2k\pi i}$$
 and, taking the  $n$ th root of both sides,

$$z = r^{\frac{1}{n}} e^{\frac{i(\theta+2k\pi)}{n}}$$

$$= r^{\frac{1}{n}} e^{\frac{i(\theta+2k\pi)}{n}} \quad k = 0, 1, 2, 3, \dots, (n-1).$$

These roots can be illustrated on an Argand diagram as before. All lie on the circle  $|z| = r^{\frac{1}{n}}$  and are equally spaced around the circle at intervals of  $\frac{2\pi}{n}$ . When  $k = 0$ ,  $z = r^{\frac{1}{n}} e^{\frac{i\theta}{n}}$  and this could be taken as the starting point for the intervals of  $\frac{2\pi}{n}$ .

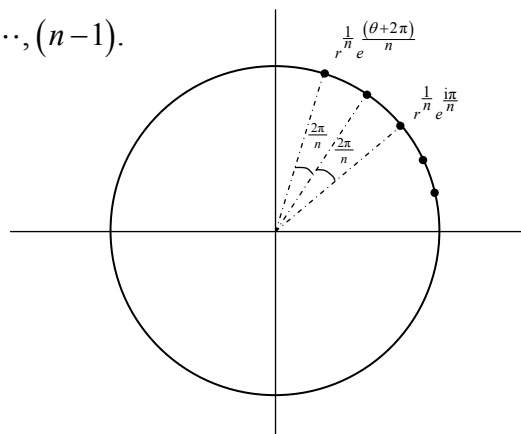

The equation  $z^n = \alpha$ , where  $\alpha = re^{i\theta}$ ,  
has roots  $z = r^{\frac{1}{n}} e^{\frac{i(\theta+2k\pi)}{n}} \quad k = 0, 1, 2, \dots, (n-1)$

**Example 4.7.1**

Find the three roots of the equation  $z^3 = 2 + 2i$ .

**Solution**

First,  $2 + 2i$  must be expressed in exponential form.

From the diagram alongside,

$$r = \sqrt{2^2 + 2^2} = \sqrt{8}, \quad \tan \theta = 1, \quad \text{and} \quad \theta = \frac{\pi}{4}.$$

So,  $2 + 2i = \sqrt{8} e^{\frac{\pi i}{4}}.$

Hence,  $z^3 = \sqrt{8} e^{\left(\frac{\pi}{4} + 2k\pi i\right)}.$

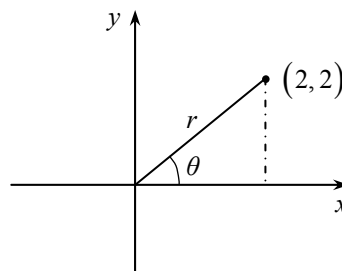

Taking the cube root of each side,

$$\begin{aligned} z &= \sqrt[3]{\sqrt{8} e^{\left(\frac{\pi i}{4} + 2k\pi i\right)}} \\ &= \sqrt{2} e^{\frac{(1+8k)\pi i}{12}} \quad k = 0, 1, 2. \end{aligned}$$

So the roots are

$$\begin{aligned} k = 0, \quad z &= \sqrt{2} e^{\frac{\pi i}{12}} \\ k = 1, \quad z &= \sqrt{2} e^{\frac{9\pi i}{12}} \\ k = 2, \quad z &= \sqrt{2} e^{\frac{17\pi i}{12}} \quad \left( \text{or } \sqrt{2} e^{-\frac{7\pi i}{12}} \right). \end{aligned}$$

The roots can also be written  $\sqrt{2} \left( \cos \frac{\pi}{12} + i \sin \frac{\pi}{12} \right)$  when  $k = 0$ , and so on.

This chapter closes with one further example of the use of the principles discussed.

**Example 4.7.2**

Solve the equation  $(z+1)^5 = z^5$  giving your answers in the form  $a + ib$ .

**Solution**

At first sight, it is tempting to use the binomial expansion on  $(z+1)^5$  but this generates a quartic equation (the terms in  $z^5$  cancel) which would be difficult to solve. Instead, because  $e^{2k\pi i} = 1$ , the equation can be written as

$$(z+1)^5 = e^{2k\pi i} z^5.$$

Taking the fifth root of each side,

$$z + 1 = e^{\frac{2k\pi i}{5}} z \quad k = 1, 2, 3, 4.$$

Note that  $k = 0$  is excluded because this would give  $z + 1 = z$ , and in any case as the equation is really a quartic equation it will have only four roots.

Solving the equation for  $z$ ,

$$1 = z \left( e^{\frac{2k\pi i}{5}} - 1 \right) \quad k = 1, 2, 3, 4$$

or

$$z = \frac{1}{e^{\frac{2k\pi i}{5}} - 1}.$$

The next step is new to this section and is well worth remembering. The term  $e^{\frac{2k\pi i}{5}}$  can be written as  $\cos \frac{2k\pi}{5} + i \sin \frac{2k\pi}{5}$  making the denominator have the form  $p + iq$ . The numerator and denominator of the right-hand side of the equation can then be multiplied by  $p - iq$  to remove  $i$  from the denominator. As  $p$  would then equal  $\cos \frac{2k\pi}{5} - 1$  and  $q$  would equal  $\sin \frac{2k\pi}{5}$ , this would be a rather cumbersome method. Instead, the numerator and

denominator of the right-hand side of the equation are multiplied by  $e^{-\frac{k\pi i}{5}}$  (for reasons which will be apparent later).

Thus,

$$z = \frac{1}{e^{\frac{2k\pi i}{5}} - 1},$$

So

$$\begin{aligned} z &= \frac{e^{-\frac{k\pi i}{5}}}{\left( e^{\frac{2k\pi i}{5}} e^{-\frac{k\pi i}{5}} \right) - e^{-\frac{k\pi i}{5}}} \\ &= \frac{e^{-\frac{k\pi i}{5}}}{e^{\frac{k\pi i}{5}} - e^{-\frac{k\pi i}{5}}}. \end{aligned}$$

But  $\frac{e^{i\theta} - e^{-i\theta}}{2i} = \sin \theta$  so that  $e^{\frac{k\pi i}{5}} - e^{-\frac{k\pi i}{5}} = 2i \sin \frac{k\pi}{5}$  and so,

$$\begin{aligned} z &= \frac{e^{-\frac{k\pi i}{5}}}{2i \sin \frac{k\pi}{5}} \\ &= \frac{\cos\left(-\frac{k\pi}{5}\right) + i \sin\left(-\frac{k\pi}{5}\right)}{2i \sin \frac{k\pi}{5}} \\ &= \frac{1}{2i} \cot\left(\frac{k\pi}{5}\right) - \frac{1}{2} \\ &= -\frac{1}{2} - \frac{1}{2} i \cot\left(\frac{k\pi}{5}\right) \quad k = 1, 2, 3, 4 \text{ as required} \end{aligned}$$

**Exercise 4G**

1. Solve the following equations:

(a)  $z^4 = 16i$

(b)  $z^3 = 1 - i$

(c)  $z^8 = 1 - \sqrt{3}i$

(d)  $z^2 = -1$

(e)  $(z+1)^3 = 8i$

(f)  $(z-1)^5 = z^5$



**Miscellaneous exercises 4**

1. (a) Write down the modulus and argument of the complex number  $-64$ .
- (b) Hence solve the equation  $z^4 + 64 = 0$  giving your answers in the form  $r(\cos \theta + i \sin \theta)$ , where  $r > 0$  and  $-\pi < \theta \leq \pi$ .
- (c) Express each of these four roots in the form  $a + ib$  and show, with the aid of a diagram, that the points in the complex plane which represent them form the vertices of a square.

[AEB June 1996]

2. (a) Express each of the complex numbers

$$1 + i \quad \text{and} \quad \sqrt{3} - i$$

in the form  $r(\cos \theta + i \sin \theta)$ , where  $r > 0$  and  $-\pi < \theta \leq \pi$ .

- (b) Using your answers to part (a),

(i) show that 
$$\frac{(\sqrt{3} - i)^5}{(1 + i)^{10}} = -\frac{1}{2} + \frac{\sqrt{3}}{2}i,$$

(ii) solve the equation 
$$z^3 = (1 + i)(\sqrt{3} - i)$$

giving your answers in the form  $a + ib$ , where  $a$  and  $b$  are real numbers to be determined to two decimal places.

[AQA June 2001]

3. (a) By considering  $z = \cos \theta + i \sin \theta$  and using de Moivre's theorem, show that

$$\sin 5\theta \equiv \sin \theta (16 \sin^4 \theta - 20 \sin^2 \theta + 5).$$

- (b) Find the exact values of the solutions of the equation

$$16x^4 - 20x^2 + 5 = 0.$$

- (c) Deduce the exact values of  $\sin \frac{\pi}{5}$  and  $\sin \frac{2\pi}{5}$ , explaining clearly the reasons for your answers.

[AQA January 2002]

4. (a) Show that the non-real cube roots of unity satisfy the equation

$$z^2 + z + 1 = 0.$$

- (b) The real number  $a$  satisfies the equation

$$\frac{1}{a - \omega + \omega^2} + \frac{1}{a + \omega - \omega^2} = \frac{1}{2},$$

where  $\omega$  is one of the non-real cube roots of unity. Find the possible values of  $a$ .

[AQA June 2000]

5. (a) Verify that  $z_1 = 1 + e^{\frac{\pi i}{5}}$   
is a root of the equation  $(z - 1)^5 = -1$ .

- (b) Find the other four roots of the equation.

- (c) Mark on an Argand diagram the points corresponding to the five roots of the equation. Show that these roots lie on a circle, and state the centre and radius of the circle.

- (d) By considering the Argand diagram, find

(i)  $\arg z_1$  in terms of  $\pi$ ,

(ii)  $|z_1|$  in the form  $a \cos \frac{\pi}{b}$ , where  $a$  and  $b$  are integers to be determined.

[AQA Specimen]

6. (a) (i) Show that  $w = e^{\frac{2\pi i}{5}}$  is one of the fifth roots of unity.

- (ii) Show that the other fifth roots of unity are  $1$ ,  $w^2$ ,  $w^3$  and  $w^4$ .

- (b) Let  $p = w + w^4$  and  $q = w^2 + w^3$ , where  $w = e^{\frac{2\pi i}{5}}$ .

(i) Show that  $p + q = -1$  and  $pq = -1$ .

- (ii) Write down the quadratic equation, with integer coefficients, whose roots are  $p$  and  $q$ .

- (iii) Express  $p$  and  $q$  as integer multiples of  $\cos \frac{2\pi}{5}$  and  $\cos \frac{4\pi}{5}$ , respectively,

- (iv) Hence obtain the values of  $\cos \frac{2\pi}{5}$  and  $\cos \frac{4\pi}{5}$  in surd form.

[NEAB June 1998]

7. (a) (i) Use de Moivre's theorem to show that if  $z = \cos \theta + i \sin \theta$ , then

$$z^n + \frac{1}{z^n} = 2 \cos n\theta.$$

- (ii) Write down the corresponding result for  $z^n - \frac{1}{z^n}$ .

- (b) (i) Show that

$$\left(z + \frac{1}{z}\right)^3 \left(z - \frac{1}{z}\right)^3 = A\left(z^6 - \frac{1}{z^6}\right) + B\left(z^2 - \frac{1}{z^2}\right),$$

where  $A$  and  $B$  are numbers to be determined.

- (ii) By substituting  $z = \cos \theta + i \sin \theta$  in the above identity, deduce that

$$\cos^3 \theta \sin^3 \theta = \frac{1}{32}(3 \sin 2\theta - \sin 6\theta).$$

[AQA June 2000]

8. (a) (i) Express  $e^{\frac{i\theta}{2}} - e^{-\frac{i\theta}{2}}$  in terms of  $\sin \frac{\theta}{2}$ .

- (ii) Hence, or otherwise, show that

$$\frac{1}{e^{i\theta} - 1} = -\frac{1}{2} - \frac{i}{2} \cot \frac{\theta}{2}, \quad (e^{i\theta} \neq 1).$$

- (b) Derive expressions, in the form  $e^{i\theta}$  where  $-\pi < \theta \leq \pi$ , for the four non-real roots of the equation  $z^6 = 1$ .

- (c) The equation 
$$\left(\frac{w+1}{w}\right)^6 = 1 \quad (*)$$

has one real root and four non-real roots.

- (i) Explain why the equation has only five roots in all.

- (ii) Find the real root.

- (iii) Show that the non-real roots are

$$\frac{1}{z_1 - 1}, \quad \frac{1}{z_2 - 1}, \quad \frac{1}{z_3 - 1}, \quad \frac{1}{z_4 - 1},$$

where  $z_1, z_2, z_3$  and  $z_4$  are the non-real roots of the equation  $z^6 = 1$ .

- (iv) Deduce that the points in an Argand diagram that represents the roots of equation (\*) lie on a straight line.

[AQA March 2000]

9. (a) Express the complex number  $2 + 2i$  in the form  $re^{i\theta}$ , where  $r > 0$  and  $-\pi < \theta \leq \pi$ .

(b) Show that one of the roots of the equation

$$z^3 = 2 + 2i$$

is  $\sqrt{2} e^{i\frac{\pi}{12}}$ , and find the other two roots giving your answers in the form  $re^{i\theta}$ , where  $r$  is a surd and  $-\pi < \theta \leq \pi$ .

(c) Indicate on an Argand diagram points  $A$ ,  $B$  and  $C$  corresponding to the three roots found in part (b).

(d) Find the area of the triangle  $ABC$ , giving your answer in surd form.

(e) The point  $P$  lies on the circle through  $A$ ,  $B$  and  $C$ . Denoting by  $w$ ,  $\alpha$ ,  $\beta$  and  $\gamma$  the complex numbers represented by  $P$ ,  $A$ ,  $B$  and  $C$ , respectively, show that

$$\left| (w - \alpha)^2 + (w - \beta)^2 + (w - \gamma)^2 \right| = 6.$$

[AQA June 1999]

## Chapter 5: Inverse Trigonometrical Functions

- 5.1 Introduction and revision
- 5.2 The derivatives of standard inverse trigonometrical functions
- 5.3 Applications to more complex differentiation
- 5.4 Standard integrals integrating to inverse trigonometrical functions
- 5.5 Applications to more complex integrals

---

---

This chapter revises and extends work on inverse trigonometrical functions. When you have studied it, you will:

- be able to recognise the derivatives of standard inverse trigonometrical functions;
- be able to extend techniques already familiar to you to differentiate more complicated expressions;
- be able to recognise algebraic expressions which integrate to standard integrals;
- be able to rewrite more complicated expressions in a form that can be reduced to standard integrals.

## 5.1 Introduction and revision

You should have already met the inverse trigonometrical functions when you were studying the A2 specification module Core 3. However, in order to present a clear picture, and for the sake of completeness some revision is included in this section.

If  $y = \sin x$ , we write  $x = \sin^{-1} y$  (or  $\arcsin y$ ). Note that  $\sin^{-1} y$  is **not**  $\operatorname{cosec} y$  which would normally be written as  $(\sin y)^{-1}$  when expressed in terms of sine.

The use of the superscript -1 is merely the convention we use to denote an inverse in the same way as we say that  $f^{-1}$  is the inverse of the function  $f$ . The sketch of  $y = \sin x$  will be familiar to you and is shown below.

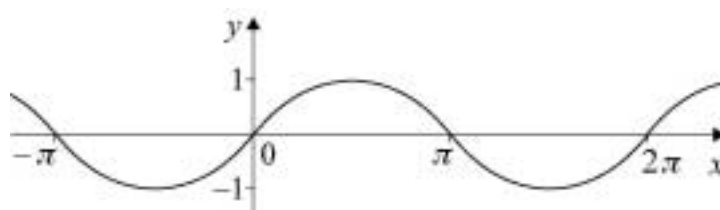

For any given value of  $x$  there is only one corresponding value of  $y$ , but for any given value of  $y$  there are infinitely many values of  $x$ . The graph of  $y = \sin^{-1} x$  being the inverse, is the reflection of  $y = \sin x$  in the line  $y = x$  and a sketch of it is as shown.

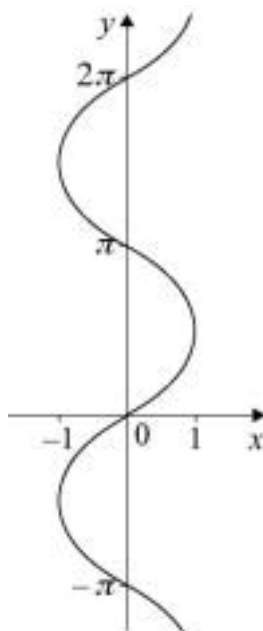

As it stands, for a given value of  $x$ ,  $y = \sin^{-1} x$  has infinitely many values, but if we wish to describe  $\sin^{-1} x$  as a function, we must make sure that the function has precisely one value.

In order to overcome this obstacle, we restrict the range of  $y$  to  $-\frac{\pi}{2} \leq y \leq \frac{\pi}{2}$  so that the sketch of  $y = \sin^{-1} x$  becomes the sketch shown.

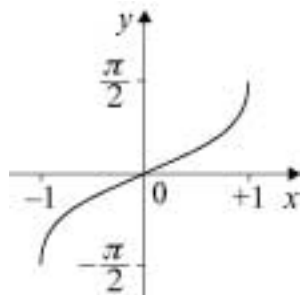

By doing this, we ensure that for any given value of  $x$  there is a unique value of  $y$  for which  $y = \sin^{-1} x$ . This value is usually called the principal value.

$\sin^{-1} x$  is the angle between  $-\frac{1}{2}\pi$  and  $\frac{1}{2}\pi$  inclusive whose sine is  $x$ .

Notice that the gradient of  $y = \sin^{-1} x$  is always greater than zero.

We can define  $\cos^{-1} x$  in a similar way but with an important difference. The sketches of  $y = \cos x$  and  $y = \cos^{-1} x$  are shown below.

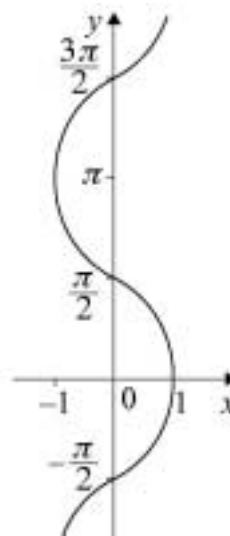
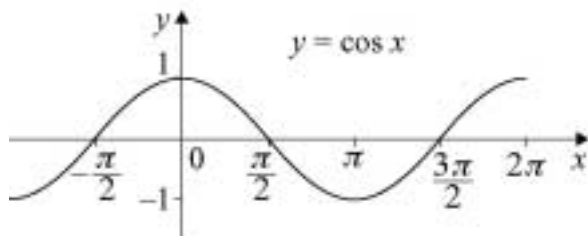

In this case, it would not be sensible to restrict  $y$  to values between  $-\frac{\pi}{2}$  and  $\frac{\pi}{2}$  since for every value of  $x \geq 0$  there would be two values of  $y$  and for values of  $x < 0$  there would be no value of  $y$ . Instead we choose the range  $0 \leq x \leq \pi$  and the sketch is as shown.

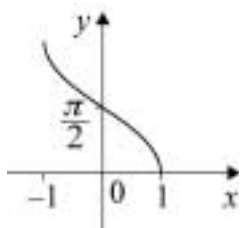

$\cos^{-1} x$  is the angle between  $0$  and  $\pi$  inclusive whose cosine is  $x$ .

When it comes to  $\tan^{-1} x$  we can restrict the range to  $-\frac{\pi}{2}$  and  $\frac{\pi}{2}$ .

$\tan^{-1} x$  is the angle between  $-\frac{\pi}{2}$  and  $+\frac{\pi}{2}$  inclusive whose tangent is  $x$ .

The sketch of  $y = \tan^{-1} x$  is shown below.

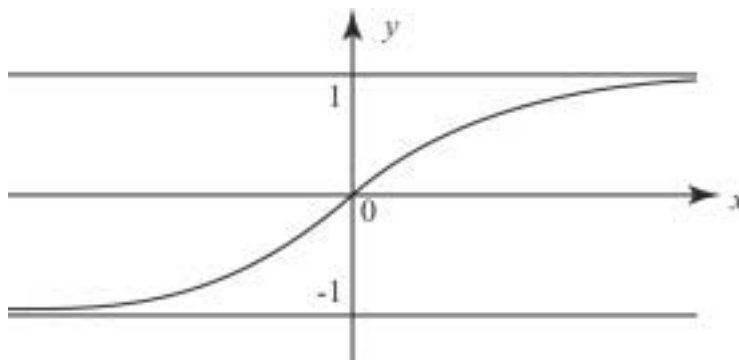

### Exercise 5A

1. Express in terms of  $\pi$  the values of:

- |                   |  |   |
|-------------------|--|---|
| (a) $\tan^{-1} 1$ | (b) $\cos^{-1} \frac{\sqrt{3}}{2}$               | (c) $\sin^{-1} \left(-\frac{1}{2}\right)$ |
| (d) $\cos^{-1} 0$ | (e) $\tan^{-1} \left(-\frac{1}{\sqrt{3}}\right)$ | (f) $\cos^{-1}(-1)$                       |



## 5.2 The derivatives of standard inverse trigonometrical functions

Suppose  $y = \sin^{-1} x$   
then  $\sin y = x$

and, differentiating implicitly,

$$\cos y \frac{dy}{dx} = 1$$

thus

$$\begin{aligned} \frac{dy}{dx} &= \frac{1}{\cos y} \\ &= \frac{1}{\sqrt{1 - \sin^2 y}} \quad \text{using } \cos^2 y + \sin^2 y = 1 \\ &= \frac{1}{\sqrt{1 - x^2}} \end{aligned}$$

Note that we choose the positive square root. This is due to the fact that the gradient of the graph of  $y = \sin^{-1} x$  is always greater than zero as was shown earlier.

$$\begin{aligned} \text{If } y &= \sin^{-1} x \\ \frac{dy}{dx} &= \frac{1}{\sqrt{1 - x^2}} \end{aligned}$$

For  $y = \cos^{-1} x$  using similar working we would arrive at  $\frac{dy}{dx} = -\frac{1}{\sqrt{1 - x^2}}$ , this time choosing the negative sign of the square root as the graph of  $y = \cos^{-1} x$  always has a gradient less than zero.

$$\begin{aligned} \text{If } y &= \cos^{-1} x \\ \frac{dy}{dx} &= -\frac{1}{\sqrt{1 - x^2}} \end{aligned}$$

If  $y = \tan^{-1} x$

then we write  $\tan y = x$ ,

and, differentiating implicitly,

$$\sec^2 y \frac{dy}{dx} = 1$$

or

$$\frac{dy}{dx} = \frac{1}{\sec^2 y}$$

$$= \frac{1}{1 + \tan^2 y} \quad \text{using } \sec^2 y = 1 + \tan^2 y$$

$$\frac{dy}{dx} = \frac{1}{1 + x^2}$$

If  $y = \tan^{-1} x$

$$\frac{dy}{dx} = \frac{1}{1 + x^2}$$

### Exercise 5B

1. Prove that if  $y = \cos^{-1} x$  then  $\frac{dy}{dx} = -\frac{1}{\sqrt{1-x^2}}$ .

### 5.3 Applications to more complex differentiation

Some methods of differentiation you should already be familiar with. These would include the function of a function rule, and the product and quotient rules. We will complete this section by using the rules with functions involving inverse trigonometrical functions.

#### Example 5.3.1

If  $y = \sin^{-1}(2x-1)$ , find  $\frac{dy}{dx}$ .

#### Solution

Set  $u = 2x-1$  then  $y = \sin^{-1} u$

$$\frac{du}{dx} = 2 \quad \text{and} \quad \frac{dy}{du} = \frac{1}{\sqrt{1-u^2}}$$

Thus,

$$\begin{aligned} \frac{dy}{dx} &= \frac{dy}{du} \times \frac{du}{dx} = \frac{2}{\sqrt{1-u^2}} \\ &= \frac{2}{\sqrt{1-(2x-1)^2}} \quad (\text{using the function of a function rule}). \\ &= \frac{2}{\sqrt{4x-4x^2}} \\ &= \frac{2}{2\sqrt{x-x^2}} \\ &= \frac{1}{\sqrt{x-x^2}} \end{aligned}$$

#### Example 5.3.2

Differentiate  $\sin^{-1} e^x$ .

Set  $u = e^x$  and let  $y = \sin^{-1} e^x$

so that  $y = \sin^{-1} u$

$$\frac{du}{dx} = e^x \quad \frac{dy}{du} = \frac{1}{\sqrt{1-u^2}}$$

and using the function of a function rule,

$$\begin{aligned} \frac{dy}{dx} &= \frac{dy}{du} \times \frac{du}{dx} = e^x \times \frac{1}{\sqrt{1-u^2}} \\ &= \frac{e^x}{\sqrt{1-e^{2x}}} \end{aligned}$$

**Example 5.3.3**

If  $y = x^2 \tan^{-1} 2x$ , find  $\frac{dy}{dx}$ .

This time we need to use the product rule and the function of a function rule.

$$y = x^2 \tan^{-1} 2x$$

$$\frac{dy}{dx} = 2x \tan^{-1} 2x + x^2 \frac{d}{dx}(\tan^{-1} 2x)$$

For  $\frac{d}{dx}(\tan^{-1} 2x)$ , set  $u = 2x$  then  $\frac{d}{dx}(\tan^{-1} 2x) = \frac{d}{du}(\tan^{-1} u) \times \frac{du}{dx}$

$$= \frac{1}{1+u^2} \times 2$$

$$= \frac{2}{1+4x^2}$$

Thus  $\frac{dy}{dx} = 2x \tan^{-1} 2x + \frac{2x^2}{1+4x^2}$ .

**Example 5.3.4**

Differentiate  $\frac{\cos^{-1} x}{\sqrt{1-x^2}}$

$$\text{If } y = \frac{\cos^{-1} x}{\sqrt{1-x^2}}$$

Then, using the quotient rule,

$$\frac{dy}{dx} = \frac{\sqrt{1-x^2} \left( -\frac{1}{\sqrt{1-x^2}} \right) - \cos^{-1} x \times \frac{1}{2} (1-x^2)^{-\frac{1}{2}} \times (-2x)}{(1-x^2)}$$

$$= \frac{-1}{1-x^2} + \frac{x \cos^{-1} x}{(1-x^2)^{\frac{3}{2}}}$$

**Exercise 5C**

Differentiate the following:

1. (a)  $\tan^{-1} 3x$

(b)  $\cos^{-1}(3x-1)$

(c)  $\sin^{-1} 2x$

2. (a)  $x \tan^{-1} x$

(b)  $e^x \cos^{-1} 2x$

(c)  $x^2 \sin^{-1}(2x-3)$

3. (a)  $\frac{\sin^{-1} 3x}{x^3}$

(b)  $\frac{\tan^{-1}(3x^2+1)}{1+x^2}$

4. (a)  $\sin^{-1}(ax+b)$

(b)  $\tan^{-1}(ax+b)$  where  $a$  and  $b$  are positive numbers.

## 5.4 Standard integrals integrating to inverse trigonometrical functions

Generally speaking, as you have been taught, formulae from the Formulae and Statistical Tables Booklet supplied for each AS and A2 module apart from MPC1 can be quoted without proof. However, this does not preclude a question requiring a proof of a result from this booklet being set. There are two standard results, the proofs of which are given here and the methods for these proofs should be committed to memory.

The first one is  $\int \frac{dx}{a^2 + x^2}$

This integral requires a substitution.

Let  $x = a \tan \theta$  so that  $dx = a \sec^2 \theta d\theta$

$$\begin{aligned} \text{Then } \int \frac{dx}{a^2 + x^2} &= \int \frac{a \sec^2 \theta d\theta}{a^2 + a^2 \tan^2 \theta} \\ &= \int \frac{a \sec^2 \theta d\theta}{a^2 \sec^2 \theta} \\ &= \int \frac{1}{a} d\theta \\ &= \frac{1}{a} \theta + c \\ &= \frac{1}{a} \tan^{-1} \frac{x}{a} + c \end{aligned}$$

$$\int \frac{dx}{a^2 + x^2} = \frac{1}{a} \tan^{-1} \frac{x}{a} + c$$

The second integral is  $\int \frac{dx}{\sqrt{a^2 - x^2}}$

This interval also requires a substitution

$$\begin{aligned} \text{Let } x &= a \sin \theta & dx &= a \cos \theta d\theta \\ \text{Then } \int \frac{dx}{\sqrt{a^2 - x^2}} &= \int \frac{a \cos \theta d\theta}{\sqrt{a^2 - a^2 \sin^2 \theta}} \\ &= \int \frac{a \cos \theta}{a \cos \theta} d\theta \\ &= \theta + c \\ &= \sin^{-1} \left( \frac{x}{a} \right) + c \end{aligned}$$

$$\int \frac{dx}{\sqrt{a^2 - x^2}} = \sin^{-1} \left( \frac{x}{a} \right) + c$$

We now give two examples of definite integrals.

**Example 5.4.1**

Evaluate  $\int_0^2 \frac{dx}{4+x^2}$

$$\begin{aligned} \text{We have } \int_0^2 \frac{dx}{4+x^2} &= \left[ \frac{1}{2} \tan^{-1} \frac{x}{2} \right]_0^2 \\ &= \frac{1}{2} \tan^{-1} 1 - \frac{1}{2} \tan^{-1} 0 \\ &= \frac{1}{2} \times \frac{\pi}{4} - 0 \\ &= \frac{\pi}{8} \end{aligned}$$

**Example 5.4.2**

Evaluate  $\int_0^{\frac{3}{2}} \frac{dx}{\sqrt{9-x^2}}$

$$\begin{aligned} \text{We have } \int_0^{\frac{3}{2}} \frac{dx}{\sqrt{9-x^2}} &= \left[ \sin^{-1} \left( \frac{x}{3} \right) \right]_0^{\frac{3}{2}} \\ &= \sin^{-1} \left( \frac{\frac{3}{2}}{3} \right) - \sin^{-1} 0 \\ &= \sin^{-1} \frac{1}{2} - \sin^{-1} 0 \\ &= \frac{\pi}{6} - 0 \\ &= \frac{\pi}{6} \end{aligned}$$

**Exercise 5D**

Integrate the following, leaving your answers in terms of  $\pi$ .

1.  $\int_1^{\sqrt{3}} \frac{2dx}{1+x^2}$

2.  $\int_{\frac{1}{2}}^1 \frac{3dx}{\sqrt{1-x^2}}$

3.  $\int_{-3}^4 \frac{dx}{\sqrt{25-x^2}}$

4.  $\int_0^1 \frac{dx}{1+x^2}$

5.  $\int_{-\frac{1}{\sqrt{3}}}^{\sqrt{3}} \frac{dx}{x^2+1}$

## 5.5 Applications to more complex integrals

In this section we will show you by means of examples how unfamiliar integrals can often be reduced to one or perhaps two, standard integrals. Most will involve completing the square of a quadratic expression, a method you will no doubt have used many times before in other contexts. We will begin by using examples of integrals which in whole or part reduce to

$$\int \frac{dx}{a^2 + x^2}.$$

### Example 5.5.1

Find  $\int \frac{dx}{x^2 + 4x + 8}$ .

Now  $x^2 + 4x + 8 = (x + 2)^2 + 4$  on completing the square so that

$$\int \frac{dx}{x^2 + 4x + 8} = \int \frac{dx}{(x + 2)^2 + 4}$$

The substitution  $u = x + 2$  gives  $du = dx$  and becomes  $\int \frac{du}{u^2 + 4}$  a standard form. The result is

therefore  $\frac{1}{2} \tan^{-1} \frac{u}{2} + c$  or expressing it in terms of  $x$ ,  $\frac{1}{2} \tan^{-1} \frac{(x + 2)}{2} + c$ .

### Example 5.5.2

Find  $\int \frac{dx}{4x^2 + 4x + 2}$

We write  $4x^2 + 4x + 2 = (2x + 1)^2 + 1$  so that we have  $\int \frac{dx}{(2x + 1)^2 + 1}$ . The substitution

$u = 2x + 1$  gives  $du = 2dx$  and the integral becomes

$$\begin{aligned} & \int \frac{\frac{1}{2} du}{u^2 + 1} \\ &= \frac{1}{2} \tan^{-1} u + c \end{aligned}$$

or substituting back

$$= \frac{1}{2} \tan^{-1} (2x + 1) + c$$



**Example 5.5.3**

Find  $\int \frac{x dx}{x^4 + 9}$

Here the substitution  $u = x^2$  transforms the given integral into standard form for if  $u = x^2$

$du = 2x dx$  and we have  $\int \frac{\frac{1}{2} du}{u^2 + 9}$

$$= \frac{1}{2} \times \frac{1}{3} \tan^{-1} \frac{u}{3} + c$$

$$= \frac{1}{6} \tan^{-1} \frac{x^2}{3} + c$$

Finally we give a slightly harder example of an integral which uses  $\int \frac{dx}{a^2 + x^2}$  in its solution.

**Example 5.5.4**

Find  $\int \frac{x+5}{x^2 + 6x + 12} dx$ .

Integrals of this type where the numerator is a linear expression in  $x$  and the denominator is a quadratic in  $x$  usually integrate to  $\ln p(x) + \tan^{-1} q(x)$  where  $p(x)$  and  $q(x)$  are functions of  $x$ . In order to tackle this integral you need to remember that integrals of the form  $\int \frac{f'(x) dx}{f(x)}$  integrate to  $\ln f(x) + c$ . You should have been taught this result when studying the module Core 3.

So to start evaluating this integral we have to note that the derivative of  $x^2 + 6x + 12$  is  $2x + 6$  and we rewrite the numerator of the integral as  $\frac{1}{2}(2x + 6) + 2$  so that the integral becomes

$$\int \frac{\frac{1}{2}(2x + 6) + 2}{x^2 + 6x + 12} dx$$

and separating it into two halves we write it again as

$$\int \frac{\frac{1}{2}(2x + 6) dx}{x^2 + 6x + 12} + \int \frac{2 dx}{x^2 + 6x + 12}$$

The first integral integrates to  $\frac{1}{2} \ln(x^2 + 6x + 12)$  whilst in the second we complete the square in the denominator and write it as

$$\int \frac{2dx}{(x+3)^2 + 3}$$

The substitution  $u = x + 3$  leads to

$$\begin{aligned} \int \frac{2du}{u^2 + 3} \\ &= \frac{2}{\sqrt{3}} \tan^{-1} \frac{u}{\sqrt{3}} \\ &= \frac{2}{\sqrt{3}} \tan^{-1} \left( \frac{x+3}{\sqrt{3}} \right) \end{aligned}$$

So that

$$\int \frac{x+5}{x^2 + 6x + 12} dx = \frac{1}{2} \ln(x^2 + 6x + 12) + \frac{2}{\sqrt{3}} \tan^{-1} \left( \frac{x+3}{\sqrt{3}} \right) + c$$

The final part of this section will show you how integrals can sometimes be reduced to  $\int \frac{dx}{\sqrt{a^2 - x^2}}$ . This will be done by means of examples.

### Example 5.5.5

Find  $\int \frac{dx}{\sqrt{4x - x^2}}$ .

As in previous examples, we need to complete the square on  $4x - x^2$ , and we write

$$4x - x^2 = 4 - (x - 2)^2$$

So that the integral becomes

$$\int \frac{dx}{\sqrt{4 - (x - 2)^2}}$$

The substitution  $u = x - 2$  simplifies the result to the standard form

$$\begin{aligned} \int \frac{du}{\sqrt{4-u^2}} \\ &= \sin^{-1} \frac{u}{2} + c \\ &= \sin^{-1} \frac{(x-2)}{2} + c \end{aligned}$$

### Example 5.5.6

Find  $\int \frac{dx}{\sqrt{1+6x-3x^2}}$ .

In order to complete the square in the denominator, we write

$$\begin{aligned} 6x - 3x^2 &= 3(2x - x^2) \\ &= 1 + 3(1 - (x-1)^2) \\ &= 4 - 3(x-1)^2 \end{aligned}$$

Thus,

$$\int \frac{dx}{\sqrt{1+6x-3x^2}} = \int \frac{dx}{\sqrt{4-3(x-1)^2}}$$

The substitution of  $u = \sqrt{3}(x-1)$  reduces the integral to

$$\begin{aligned} \int \frac{du}{\sqrt{3}\sqrt{4-u^2}} \\ &= \frac{1}{\sqrt{3}} \sin^{-1} \frac{u}{2} + c \\ &= \frac{1}{\sqrt{3}} \sin^{-1} \frac{\sqrt{3}(x-1)}{2} + c \end{aligned}$$

One final example shows how more complicated expressions may be integrated using methods shown here and other results which you should have met studying earlier modules. In this particular context the result you will need is that

$$\int \frac{f'(x)}{\sqrt{f(x)}} dx = 2\sqrt{f(x)} + c$$

[This result can be easily verified using the substitution  $u = f(x)$ , since then,  $du = f'(x) dx$  and the integral becomes  $\int \frac{du}{\sqrt{u}}$ ].

**Example 5.5.7**

Find  $\int \frac{x dx}{\sqrt{7-6x-x^2}}$ .

Now the derivative of  $7-6x-x^2$  is  $-6-2x$  so we write  $x$  as  $-\frac{1}{2}(6+2x)+3$  and the integral becomes

$$-\int \frac{-\frac{1}{2}(6+2x)+3}{\sqrt{7-6x-x^2}} dx$$

or separating the integral into two parts

$$-\int \frac{-\frac{1}{2}(6+2x)}{\sqrt{7-6x-x^2}} - \int \frac{3 dx}{\sqrt{7-6x-x^2}}$$

The first integral is of the form  $\int \frac{f'(x)}{\sqrt{f(x)}} dx$  apart from a scalar multiplier, and so integrates to

$\sqrt{7-6x-x^2}$ , whilst completing the square on the denominator of the second integral, we obtain  $\int \frac{3 dx}{\sqrt{16-(x+3)^2}}$  which integrates to  $3 \sin^{-1} \frac{x+3}{4}$  using the substitution  $u = x+3$ .

Hence,

$$\int \frac{x dx}{\sqrt{7-6x-x^2}} = -\sqrt{7-6x-x^2} - 3 \sin^{-1} \left( \frac{x+3}{4} \right) + c$$

**Exercise 5E**

1. Integrate

(a)  $\frac{1}{x^2 + 4x + 5}$

(b)  $\frac{1}{2x^2 - 4x + 5}$

(c)  $\frac{1}{x^2 - x + 2}$

2. Integrate

(a)  $\frac{2x}{x^2 + 2x + 3}$

(b)  $\frac{x}{x^2 + x + 1}$

3. Find

(a)  $\int \frac{dx}{\sqrt{7 + 6x - x^2}}$

(b)  $\int \frac{dx}{\sqrt{3 + 2x - x^2}}$

(c)  $\int \frac{dx}{\sqrt{x(1 - 2x)}}$

4. Find

(a)  $\int \frac{x+1}{\sqrt{1-x^2}} dx$

(b)  $\int \frac{3x-2}{\sqrt{3+2x-x^2}} dx$

(c)  $\int \frac{(1-x)}{\sqrt{1-x-x^2}} dx$

## Chapter 6: Hyperbolic Functions

- 6.1 Definitions of hyperbolic functions
  - 6.2 Numerical values of hyperbolic functions
  - 6.3 Graphs of hyperbolic functions
  - 6.4 Hyperbolic identities
  - 6.5 Osborne's rule
  - 6.6 Differentiation of hyperbolic functions
  - 6.7 Integration of hyperbolic functions
  - 6.8 Inverse hyperbolic functions
  - 6.9 Logarithmic form of inverse hyperbolic functions
  - 6.10 Derivatives of inverse hyperbolic functions
  - 6.11 Integrals which integrate to inverse hyperbolic functions
  - 6.12 Solving equations
- 
- 

This chapter introduces you to a wholly new concept. When you have completed it, you will:

- know what hyperbolic functions are;
- be able to sketch them;
- be able to differentiate and integrate them;
- have learned some hyperbolic identities;
- understand what inverse hyperbolic functions are and how they can be expressed in alternative forms;
- be able to sketch inverse hyperbolic functions;
- be able to differentiate inverse hyperbolic functions and recognise integrals which integrate to them;
- be able to solve equations involving hyperbolic functions.

### 6.1 Definitions of hyperbolic functions

It was shown in Chapter 4 that  $\sin x = \frac{1}{2i}(e^{ix} - e^{-ix})$  and  $\cos x = \frac{1}{2}(e^{ix} + e^{-ix})$ . Hyperbolic functions are defined in a very similar way. The definitions of  $\sinh x$  and  $\cosh x$  (often called hyperbolic sine and hyperbolic cosine – pronounced ‘shine  $x$ ’ and ‘cosh  $x$ ’) are:

$$\sinh x = \frac{1}{2}(e^x - e^{-x})$$

$$\cosh x = \frac{1}{2}(e^x + e^{-x})$$

There are four other hyperbolic functions derived from these, just as there are four trigonometric functions. They are:

$\tanh x = \frac{\sinh x}{\cosh x}$	‘than $x$ ’
$\operatorname{cosech} x = \frac{1}{\sinh x}$	‘cosheck $x$ ’
$\operatorname{sech} x = \frac{1}{\cosh x}$	‘sheck $x$ ’
$\operatorname{coth} x = \frac{1}{\tanh x}$	‘coth $x$ ’

In terms of exponential functions,

$$\begin{aligned} \tanh x &= \frac{\sinh x}{\cosh x} \\ &= \frac{\frac{1}{2}(e^x - e^{-x})}{\frac{1}{2}(e^x + e^{-x})} \\ &= \frac{e^x - e^{-x}}{e^x + e^{-x}}, \end{aligned}$$

or, on multiplying the numerator and denominator by  $e^x$ ,

$$\tanh x = \frac{e^{2x} - 1}{e^{2x} + 1}.$$

Again,

$$\begin{aligned} \operatorname{cosech} x &= \frac{1}{\sinh x} \\ &= \frac{1}{\frac{1}{2}(e^x - e^{-x})} \\ &= \frac{2}{e^x - e^{-x}}. \end{aligned}$$

Exponential forms for  $\operatorname{sech} x$  and  $\operatorname{coth} x$  can be found in a similar way.

### Exercise 6A

1. Express, in terms of exponentials:

- (a)  $\operatorname{sech} x$ ,      (b)  $\operatorname{coth} x$ ,      (c)  $\tanh \frac{1}{2}x$ ,      (d)  $\operatorname{cosech} 3x$ .

## 6.2 Numerical values of hyperbolic functions

When finding the value of trigonometric functions, for example  $\sin x$ , the angle  $x$  must be given in degrees (or radians). There is no unit for  $x$  when evaluating, for example,  $\sinh x$ . It is quite in order to speak about  $\sinh 2$  or  $\cosh 1.3$ :

$$\sinh 2 = \frac{e^2 - e^{-2}}{2} = 3.63 \quad (\text{to two decimal places});$$

$$\cosh 1.3 = \frac{e^{1.3} + e^{-1.3}}{2} = 1.97 \quad (\text{to two decimal places}).$$

You can work out these values on a calculator using the  $e^x$  button. However, for convenience most scientific calculators have a 'hyp' button and  $\sinh 2$  can be obtained directly by pressing the '2', 'hyp' and 'sin' buttons in the appropriate order.

It is worth remembering that

$$\sinh 0 = \frac{e^0 - e^{-0}}{2} = \frac{1-1}{2} = 0;$$

$$\cosh 0 = \frac{e^0 + e^{-0}}{2} = \frac{1+1}{2} = 1.$$

### Exercise 6B

1. Use a calculator to evaluate, to two decimal places:

- (a)  $\sinh 0.6$ ,      (b)  $\tanh 1.3$ ,      (c)  $\operatorname{sech} 2.1$ ,  
 (d)  $\tanh (-0.6)$ ,      (e)  $\cosh (-0.3)$ ,      (f)  $\operatorname{coth} 4$



### 6.3 Graphs of hyperbolic functions

The graphs of hyperbolic functions can be sketched easily by plotting points. Some sketches are given below but it would be a good exercise to make a table of values and confirm the general shapes for yourself. It would also be worthwhile committing the general shapes of  $y = \sinh x$ ,  $y = \cosh x$  and  $y = \tanh x$  to memory.

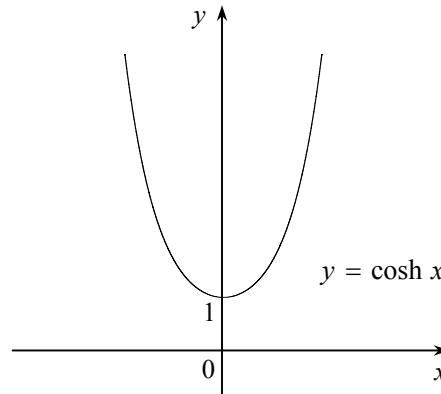
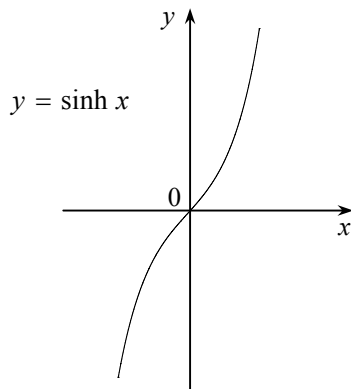

The sketch of  $y = \tanh x$  requires a little more consideration. In Section 5.1, it was shown that  $\tanh x$  could be written as

$$\begin{aligned} \tanh x &= \frac{e^{2x} - 1}{e^{2x} + 1} \\ &= -\left(\frac{1 - e^{2x}}{1 + e^{2x}}\right). \end{aligned}$$

Now, as  $e^{2x} > 0$  for all values of  $x$ , it follows that the numerator in the bracketed expression above is less than its denominator, so that  $\tanh x > -1$ . Also, as  $x \rightarrow -\infty$ ,  $e^{2x} \rightarrow 0$  and  $\tanh x \rightarrow -\left(\frac{1}{1}\right) = -1$ . So the graph of  $y = \tanh x$  has an asymptote at  $y = -1$ .

Now, if the numerator and denominator of  $\tanh x$  are divided by  $e^{2x}$ ,

$$\tanh x = \frac{1 - e^{-2x}}{1 + e^{-2x}}.$$

As  $e^{-2x} > 0$  for all values of  $x$ , it follows that the numerator of this fraction is less than its denominator, from which it can be deduced that  $\tanh x < 1$ . It can also be deduced that as  $e^{-2x} \rightarrow 0$  as  $x \rightarrow \infty$ , so  $\tanh x \rightarrow 1$  as  $x \rightarrow \infty$ . So the graph of  $y = \tanh x$  has an asymptote at  $x = 1$ . Hence the curve  $y = \tanh x$  lies between  $y = +1$  and  $y = -1$ , and has  $y = \pm 1$  as asymptotes.

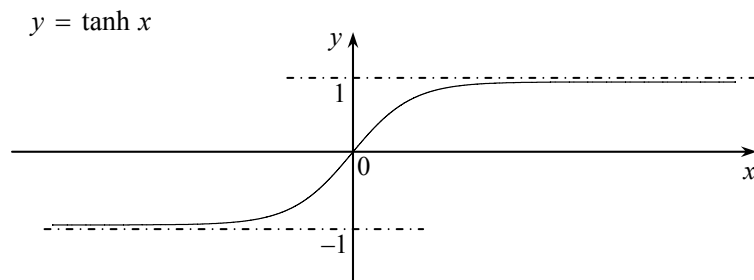

**Exercise 6C**

1. Sketch the graphs of

(a)  $y = \operatorname{sech} x$ , (b)  $y = \operatorname{cosech} x$ , (c)  $y = \operatorname{coth} x$ .

**6.4 Hyperbolic identities**

Just as there are trigonometric identities such as  $\cos^2 \theta + \sin^2 \theta = 1$  and  $\cos 2\theta = 2 \cos^2 \theta - 1$ , there are similar hyperbolic identities. For example,

$$\cosh^2 x = \left( \frac{e^x + e^{-x}}{2} \right)^2 = \frac{1}{4} (e^{2x} + 2 + e^{-2x}),$$

and 
$$\sinh^2 x = \left( \frac{e^x - e^{-x}}{2} \right)^2 = \frac{1}{4} (e^{2x} - 2 + e^{-2x})$$

from which, by subtraction,

$$\begin{aligned} \cosh^2 x - \sinh^2 x &= \frac{1}{4} (e^{2x} + 2 + e^{-2x}) - \frac{1}{4} (e^{2x} - 2 + e^{-2x}) \\ &= 1. \end{aligned}$$

$$\boxed{\cosh^2 x - \sinh^2 x = 1}$$

Dividing both sides of this equation by  $\cosh^2 x$ , it follows that

$$\begin{aligned} \frac{\cosh^2 x}{\cosh^2 x} - \frac{\sinh^2 x}{\cosh^2 x} &= \frac{1}{\cosh^2 x} \\ 1 - \tanh^2 x &= \operatorname{sech}^2 x. \end{aligned}$$

$$\boxed{\operatorname{sech}^2 x = 1 - \tanh^2 x}$$

Or again, dividing both sides by  $\sinh^2 x$  instead,

$$\begin{aligned} \frac{\cosh^2 x}{\sinh^2 x} - \frac{\sinh^2 x}{\sinh^2 x} &= \frac{1}{\sinh^2 x} \\ \coth^2 x - 1 &= \operatorname{cosech}^2 x. \end{aligned}$$

$$\boxed{\operatorname{cosech}^2 x = \coth^2 x - 1}$$

Now consider  $\sinh x \cosh y + \cosh x \sinh y$

$$\begin{aligned} &= \frac{1}{2}(e^x - e^{-x})\frac{1}{2}(e^y - e^{-y}) + \frac{1}{2}(e^x + e^{-x})\frac{1}{2}(e^y - e^{-y}) \\ &= \frac{1}{4}(e^x e^y - \cancel{e^{-x} e^y} + \cancel{e^x e^{-y}} - e^{-x} e^{-y} + e^x e^y + \cancel{e^{-x} e^y} - \cancel{e^x e^{-y}} - e^{-x} e^{-y}) \\ &= \frac{1}{4}(2e^x e^y - 2e^{-x} e^{-y}) \\ &= \frac{1}{2}(e^x e^y - e^{-x} e^{-y}) \\ &= \frac{1}{2}(e^{x+y} - e^{-(x+y)}) \quad [\text{using the laws of indices}] \\ &= \sinh(x + y). \end{aligned}$$

In exactly the same way, expressions for  $\sinh(x - y)$ ,  $\cosh(x + y)$  and  $\cosh(x - y)$  can be worked out.

$$\begin{aligned} \sinh(x \pm y) &= \sinh x \cosh y \pm \cosh x \sinh y \\ \cosh(x \pm y) &= \cosh x \cosh y \pm \sinh x \sinh y \end{aligned}$$

### Exercise 6D

1. Show that

(a)  $\sinh(x - y) = \sinh x \cosh y - \cosh x \sinh y$ ,

(b)  $\cosh(x \pm y) = \cosh x \cosh y \pm \sinh x \sinh y$ .

You will probably remember that the basic trigonometric formulae for  $\sin(x + y)$  and  $\cos(x + y)$  can be used to find expressions for  $\sin 2x$ ,  $\cos 2x$ , and so on. The hyperbolic formulae given above help to find corresponding results for hyperbolic functions.

For example,

because  $\sinh(x + y) = \sinh x \cosh y + \cosh x \sinh y$ ,

putting  $y = x$ ,

$$\sinh(x + x) = \sinh x \cosh x + \cosh x \sinh x,$$

or

$$\sinh 2x = 2 \sinh x \cosh x.$$

Using

$$\cosh(x + y) = \cosh x \cosh y + \sinh x \sinh y,$$

putting  $y = x$ ,

$$\cosh(x + x) = \cosh x \cosh x + \sinh x \sinh x,$$

or

$$\cosh 2x = \cosh^2 x + \sinh^2 x.$$

Using  $\cosh^2 x - \sinh^2 x = 1$ ,

$$\cosh 2x = 1 + \sinh^2 x + \sinh^2 x$$

$$= 1 + 2 \sinh^2 x$$

or

$$\cosh 2x = 2 \cosh^2 x - 1.$$

$$\begin{aligned} \sinh 2x &= 2 \sinh x \cosh x \\ \cosh 2x &= \cosh^2 x + \sinh^2 x \\ &= 2 \cosh^2 x - 1 \\ &= 1 + 2 \sinh^2 x \end{aligned}$$

Some examples will illustrate extensions of these results.

**Example 6.4.1**

Show that  $\tanh 2x = \frac{2 \tanh x}{1 + \tanh^2 x}$ .

**Solution**

$$\begin{aligned}\tanh 2x &= \frac{\sinh 2x}{\cosh 2x} \\ &= \frac{2 \sinh x \cosh x}{\cosh^2 x + \sinh^2 x}.\end{aligned}$$

Dividing the numerator and denominator by  $\cosh^2 x$ ,

$$\begin{aligned}\tanh 2x &= \frac{\frac{2 \sinh x \cosh x}{\cosh^2 x}}{\frac{\cosh^2 x + \sinh^2 x}{\cosh^2 x}} \\ &= \frac{\frac{2 \sinh x}{\cosh x}}{1 + \frac{\sinh^2 x}{\cosh^2 x}} \\ &= \frac{2 \tanh x}{1 + \tanh^2 x}.\end{aligned}$$

**Example 6.4.2**

Show that  $\cosh 3x = 4 \cosh^3 x - 3 \cosh x$ .

**Solution**

$$\begin{aligned}\cosh 3x &= \cosh(2x + x) \\ &= \cosh 2x \cosh x + \sinh 2x \sinh x \\ &= (2 \cosh^2 x - 1) \cosh x + 2 \sinh x \cosh x \sinh x \\ &= 2 \cosh^3 x - \cosh x + 2(\cosh^2 x - 1) \cosh x \quad [\text{using } \cosh^2 x - \sinh^2 x = 1] \\ &= 2 \cosh^3 x - \cosh x + 2 \cosh^3 x - 2 \cosh x \\ &= 4 \cosh^3 x - 3 \cosh x.\end{aligned}$$

**Exercise 6E**

- Using the expansion of  $\sinh(2x + x)$ , show that  $\sinh 3x = 3 \sinh x + 4 \sinh^3 x$ .
- Express  $\cosh 4x$  in terms of  $\cosh x$ .

## 6.5 Osborne's rule

It should be clear that the results and identities for hyperbolic functions bear a remarkable similarity to the corresponding ones for trigonometric functions. In fact the only differences are those of sign – for example, whereas  $\cos^2 x + \sin^2 x = 1$ , the corresponding hyperbolic identity is  $\cosh^2 x - \sinh^2 x = 1$ . There is a rule for obtaining the identities of hyperbolic functions from those for trigonometric functions – it is called Osborne's rule.

To change a trigonometric function into its corresponding hyperbolic function, where a product of two sines appears change the sign of the corresponding hyperbolic term

For example,

because  $\cos(x + y) = \cos x \cos y - \sin x \sin y$

then  $\cosh(x + y) = \cosh x \cosh y + \sinh x \sinh y$ .

Note also that

because  $\cos 2x = 1 - 2 \sin^2 x$

then  $\cosh 2x = 1 + 2 \sinh^2 x$ ,

because  $\sin^2 x$  is a product of two sines.

However, care must be exercised in using this rule, as the next example shows.

It is known that  $\sec^2 x = 1 + \tan^2 x$

but  $\operatorname{sech}^2 x = 1 - \tanh^2 x$

The reason that the sign has to be changed here is that a product of sines is implied because

$$\tan^2 x = \frac{\sin^2 x}{\cos^2 x}.$$

It should be noted that Osborne's rule is only an aid to memory. It must not be used in a **proof** – for example, that  $\cosh^2 x - \sinh^2 x = 1$ . The method shown in Section 5.4 must be used for that.

## 6.6 Differentiation of hyperbolic functions

You will already have met the derivative of  $e^{kx}$ . Just to remind you,

$$\frac{d}{dx}(e^{kx}) = ke^{kx}.$$

As hyperbolic functions can be expressed in terms of  $e$ , it follows that their differentiation is straightforward. For example,

$$\begin{aligned}y &= \sinh x \\ &= \frac{1}{2}(e^x - e^{-x}).\end{aligned}$$

Therefore,

$$\begin{aligned}\frac{dy}{dx} &= \frac{1}{2}(e^x + e^{-x}) \\ &= \cosh x.\end{aligned}$$

And if

$$\begin{aligned}y &= \sinh kx \\ &= \frac{1}{2}(e^{kx} - e^{-kx}),\end{aligned}$$

then

$$\begin{aligned}\frac{dy}{dx} &= \frac{1}{2}(ke^{kx} + ke^{-kx}) \\ &= k \frac{1}{2}(e^{kx} + e^{-kx}) \\ &= k \cosh kx.\end{aligned}$$

You can differentiate  $\cosh x$  and  $\cosh kx$  in exactly the same way;  $\tanh x$  can be differentiated by treating it as the derivative of the quotient  $\frac{\sinh x}{\cosh x}$ . The following results should be committed to memory:

$y = \sinh x,$	$\frac{dy}{dx} = \cosh x$
$y = \cosh x,$	$\frac{dy}{dx} = \sinh x$
$y = \tanh x,$	$\frac{dy}{dx} = \operatorname{sech}^2 x$

Generally:

$y = \sinh kx,$	$\frac{dy}{dx} = k \cosh kx$
$y = \cosh kx,$	$\frac{dy}{dx} = k \sinh kx$
$y = \tanh kx,$	$\frac{dy}{dx} = k \operatorname{sech}^2 kx$

Note that the derivatives are very similar to the derivatives of trigonometric functions, except that whereas  $\frac{d}{dx}(\cos x) = -\sin x$ ,  $\frac{d}{dx}(\cosh x) = +\sinh x$ .

### Example 6.6.1

Differentiate  $\sinh \frac{1}{2}x$ .

**Solution**

$$\begin{aligned}
 y &= \sinh \frac{1}{2}x \\
 \frac{dy}{dx} &= \cosh \frac{1}{2}x \left( \times \frac{1}{2} \right) \\
 &= \frac{1}{2} \cosh \frac{1}{2}x.
 \end{aligned}$$



**Example 6.6.2**

Differentiate  $x \cosh 2x + \cosh^4 3x$ .

**Solution**

$$\begin{aligned}y &= x \cosh 2x + \cosh^4 3x \\ &= x \cosh 2x + (\cosh 3x)^4.\end{aligned}$$

Using the product and chain rules for differentiation,

$$\begin{aligned}\frac{dy}{dx} &= (1 \times \cosh 2x) + (x \sinh 2x \times 2) + (4(\cosh 3x)^3 \times \sinh 3x \times 3) \\ &= \cosh 2x + 2x \sinh 2x + 12 \sinh 3x \cosh^3 3x.\end{aligned}$$

**Exercise 6F**

1. Differentiate the following expressions:

- (a)  $\cosh 3x$ ,      (b)  $\cosh^2 3x$ ,      (c)  $x^2 \cosh x$ ,  
(d)  $\frac{\cosh 2x}{x}$ ,      (e)  $x \tanh x$ ,      (f)  $\operatorname{sech} x$  [hint: write  $\operatorname{sech} x$  as  $(\cosh x)^{-1}$ ],  
(g)  $\operatorname{cosech} x$ .

## 6.7 Integration of hyperbolic functions

You will already have met the integral of  $e^{kx}$ . Just to remind you,

$$\int e^{kx} dx = \frac{1}{k} e^{kx}.$$

As hyperbolic functions can be expressed in terms of  $e$ , and as it is the reverse of differentiation, it follows that their integration is straightforward.

$$\begin{aligned} \int \sinh x dx &= \cosh x + c \\ \int \cosh x dx &= \sinh x + c \\ \int \operatorname{sech}^2 x dx &= \tanh x + c \end{aligned}$$

Of course, generally  $\int \sinh kx = \frac{1}{k} \cosh kx + c$ .

For the integration of  $\tanh x$ , a substitution is needed as follows:

$$\int \tanh x dx = \int \frac{\sinh x}{\cosh x} dx.$$

Putting  $u = \cosh x$ ,  $du = \sinh x dx$ .

$$\begin{aligned} \text{So that } \int \tanh x dx &= \int \frac{du}{u} \\ &= \ln u + c \\ &= \ln \cosh x + c. \end{aligned}$$

$$\begin{aligned} \int \tanh x dx &= \ln \cosh x + c \\ \int \operatorname{coth} x dx &= \ln \sinh x + c \end{aligned}$$

### Exercise 6G

1. Evaluate the following integrals:

- (a)  $\int \cosh 3x dx$ ,    (b)  $\int \cosh^2 x dx$ ,  
 (c)  $\int x \sinh 2x dx$ ,    (d)  $\int \tanh^2 x dx$ .

### 6.8 Inverse hyperbolic functions

Just as there are inverse trigonometric functions ( $\sin^{-1} x$ ,  $\cos^{-1} x$ , etc.), so there are inverse hyperbolic functions. They are defined in a similar way to inverse trigonometric functions – so, if  $x = \sinh y$ , then  $y = \sinh^{-1} x$ ; and likewise for the other five hyperbolic functions.

To find the value of, say,  $\sinh^{-1} 2$  using a calculator, you use it in the same way as you would if it was a trigonometric function (pressing the appropriate buttons for hyperbolic functions).

The sketches of  $y = \sinh^{-1} x$  and  $y = \tanh^{-1} x$  are the reflections of  $y = \sinh x$  and  $y = \tanh x$ , respectively, in the line  $y = x$ . These sketches are shown below. Note that the curve  $y = \tanh^{-1} x$  has asymptotes at  $x = \pm 1$ .

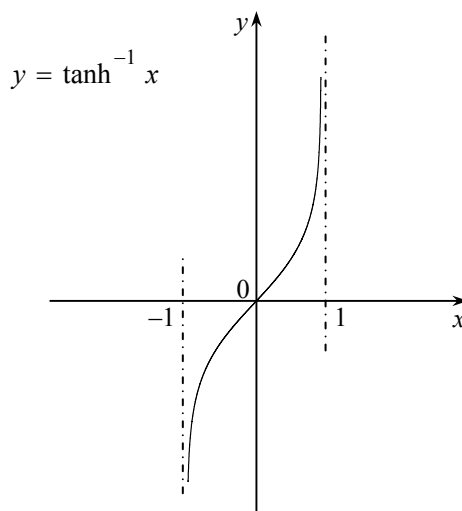
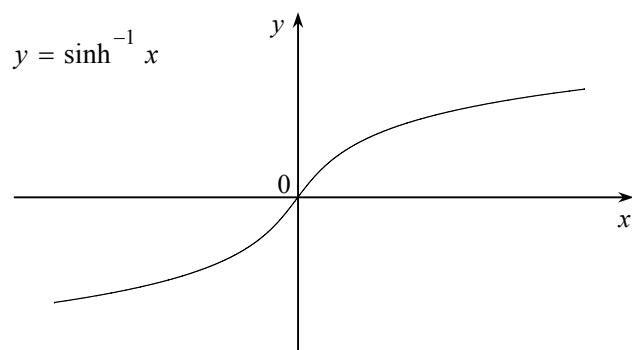

Note also that  $y = \cosh x$  does not have an inverse. This is because the mapping  $f : x \rightarrow \cosh x$  is not a one-to-one mapping. If you look at the graph of  $y = \cosh x$  (in Section 5.3) you will see that for every value of  $y > 1$  there are **two** values of  $x$ . However, if the domain of  $y = \cosh x$  is restricted to  $x \geq 0$  there will be a one-to-one mapping, and hence an inverse, and the range for the inverse will be  $y \geq 1$ .

## 6.9 Logarithmic form of inverse hyperbolic functions

The inverse hyperbolic functions  $\cosh^{-1} x$ ,  $\sinh^{-1} x$  and  $\tanh^{-1} x$  can be expressed as logarithms. For example, if

$$\begin{aligned} y &= \cosh^{-1} x, \\ \text{then } x &= \cosh y \end{aligned}$$

$$x = \frac{e^y + e^{-y}}{2}$$

$$2x = e^y + e^{-y}.$$

$$\text{Multiplying by } e^y, \quad 2xe^y = e^{2y} + 1$$

$$0 = e^{2y} - 2xe^y + 1.$$

This is a quadratic equation in  $e^y$  and can be solved using the quadratic formula:

$$e^y = \frac{2x \pm \sqrt{4x^2 - 4}}{2}$$

$$= x \pm \sqrt{x^2 - 1}.$$

Taking the logarithm of each side,

$$y = \ln(x \pm \sqrt{x^2 - 1}).$$

$$\begin{aligned} \text{Now, } (x + \sqrt{x^2 - 1})(x - \sqrt{x^2 - 1}) &= x^2 - (\sqrt{x^2 - 1})^2 \\ &= x^2 - x^2 + 1 \\ &= 1. \end{aligned}$$

$$\text{Thus } x - \sqrt{x^2 - 1} = \frac{1}{(x + \sqrt{x^2 - 1})},$$

$$\begin{aligned} \text{and } \ln(x - \sqrt{x^2 - 1}) &= \ln\left(\frac{1}{(x + \sqrt{x^2 - 1})}\right) \\ &= -\ln(x + \sqrt{x^2 - 1}), \end{aligned}$$

$$\text{so that } y = \pm \ln(x + \sqrt{x^2 - 1}).$$

However, from Section 5.8, if  $y \geq 0$  then

$$y = \cosh^{-1} x = +\ln\left(x + \sqrt{x^2 - 1}\right).$$

A similar result for  $y = \sinh^{-1} x$  can be obtained by writing  $x = \sinh y$  and then expressing  $\sinh y$  in terms of  $e^y$ . This gives  $y = \ln\left(x \pm \sqrt{x^2 + 1}\right)$ , but as  $x - \sqrt{x^2 + 1} \leq 0$  the negative sign has to be rejected because the logarithm of a negative number is non-real. Thus

$$\sinh^{-1} x = \ln\left(x + \sqrt{x^2 + 1}\right).$$

It is straightforward to obtain the logarithmic form of  $y = \tanh^{-1} x$  if, after writing

$\tanh y = x$ ,  $\tanh y$  is written as  $\frac{\sinh y}{\cosh y}$ .

$$\cosh^{-1} x = \ln\left(x + \sqrt{x^2 - 1}\right)$$

$$\sinh^{-1} x = \ln\left(x + \sqrt{x^2 + 1}\right)$$

$$\tanh^{-1} x = \frac{1}{2} \ln\left(\frac{1+x}{1-x}\right)$$

**Example 6.9.1**

Find, in logarithmic form,  $\tanh^{-1} \frac{1}{2}$ .

**Solution**

$$\begin{aligned} \tanh^{-1} \frac{1}{2} &= \frac{1}{2} \ln \left( \frac{1 + \frac{1}{2}}{1 - \frac{1}{2}} \right) \\ &= \frac{1}{2} \ln \left( \frac{\frac{3}{2}}{\frac{1}{2}} \right) \\ &= \frac{1}{2} \ln 3 \\ &= \ln \sqrt{3}. \end{aligned}$$

**Example 6.9.2**

Find, in logarithmic form,  $\sinh^{-1} \frac{3}{4}$ .

**Solution**

$$\begin{aligned} \sinh^{-1} \frac{3}{4} &= \ln \left( \frac{3}{4} + \sqrt{\left(\frac{3}{4}\right)^2 + 1} \right) \\ &= \ln \left( \frac{3}{4} + \sqrt{\frac{9}{16} + 1} \right) \\ &= \ln \left( \frac{3}{4} + \sqrt{\frac{25}{16}} \right) \\ &= \ln \left( \frac{3}{4} + \frac{5}{4} \right) \\ &= \ln 2. \end{aligned}$$

**Exercise 6H**

1. Show that  $\sinh^{-1} x = \ln(x + \sqrt{x^2 + 1})$ .
2. Show that  $\tanh^{-1} x = \frac{1}{2} \ln \left( \frac{1+x}{1-x} \right)$ .
3. Express the following in logarithmic form:
  - (a)  $\cosh^{-1} 1.5$ ,
  - (b)  $\tanh^{-1} \frac{1}{3}$ ,
  - (c)  $\sinh^{-1} \frac{5}{12}$ .

## 6.10 Derivatives of inverse hyperbolic functions

As already seen, if  $y = \sinh^{-1} x$  then  $\sinh y = x$ . Differentiating with respect to  $x$ ,

$$\cosh y \frac{dy}{dx} = 1.$$

So that

$$\begin{aligned} \frac{dy}{dx} &= \frac{1}{\cosh y} \\ &= \frac{1}{\sqrt{1+x^2}} \quad \left[ \text{using } \cosh^2 y - \sinh^2 y = 1 \right] \end{aligned}$$

Again, if  $y = \sinh^{-1} \frac{x}{a}$ ,

$$\sinh y = \frac{x}{a},$$

and

$$\cosh y \frac{dy}{dx} = \frac{1}{a}.$$

Thus

$$\begin{aligned} \frac{dy}{dx} &= \frac{1}{a \cosh y} \\ &= \frac{1}{a \sqrt{1 + \frac{x^2}{a^2}}} \\ &= \frac{1}{\sqrt{a^2 + x^2}}. \end{aligned}$$

The derivatives of  $\cosh^{-1} x$  and  $\cosh^{-1} \left( \frac{x}{a} \right)$ , and also  $\tanh^{-1} x$  and  $\tanh^{-1} \left( \frac{x}{a} \right)$  are obtained in exactly the same way.

### Example 6.10.1

Find the derivative of  $\frac{d}{dx} (\tanh^{-1} x)$ .

**Solution**

$$y = \tanh^{-1} x$$

$$\tanh y = x$$

$$\operatorname{sech}^2 y \frac{dy}{dx} = 1$$

$$\frac{dy}{dx} = \frac{1}{\operatorname{sech}^2 y}$$

$$= \frac{1}{1-x^2} \quad \left[ \text{using } \operatorname{sech}^2 y + \tanh^2 y = 1 \right].$$

It is suggested that you work through the remaining results yourself.

$y = \sinh^{-1} x :$	$\frac{dy}{dx} = \frac{1}{\sqrt{1+x^2}}$
$y = \cosh^{-1} x :$	$\frac{dy}{dx} = \frac{1}{\sqrt{x^2-1}}$
$y = \tanh^{-1} x :$	$\frac{dy}{dx} = \frac{1}{1-x^2}$

Generally,

$y = \sinh^{-1} \frac{x}{a} :$	$\frac{dy}{dx} = \frac{1}{\sqrt{a^2+x^2}}$
$y = \cosh^{-1} \frac{x}{a} :$	$\frac{dy}{dx} = \frac{1}{\sqrt{x^2-a^2}}$
$y = \tanh^{-1} \frac{x}{a} :$	$\frac{dy}{dx} = \frac{1}{a^2-x^2}$

### Example 6.10.2

Differentiate  $\cosh^{-1} \frac{x}{3}$ .

**Solution**

$$\begin{aligned}
 y &= \cosh^{-1} \frac{x}{3} \\
 \frac{dy}{dx} &= \frac{1}{\sqrt{x^2-3^2}} \\
 &= \frac{1}{\sqrt{x^2-9}}.
 \end{aligned}$$



**Example 6.10.3**

If  $y = x^2 \sinh^{-1} \frac{x}{2}$ , find  $\frac{dy}{dx}$  when  $x = 2$ , giving your answer in the form  $a + b \ln c$ .

**Solution**

Differentiate  $x^2 \sinh^{-1} \frac{x}{2}$  as a product .

$$y = x^2 \sinh^{-1} \frac{x}{2}$$

$$\frac{dy}{dx} = 2x \sinh^{-1} \frac{x}{2} + x^2 \frac{1}{\sqrt{2^2 + x^2}}.$$

So, when  $x = 2$

$$\begin{aligned} \frac{dy}{dx} &= 4 \sinh^{-1} 1 + 4 \frac{1}{\sqrt{2^2 + 2^2}} \\ &= 4 \ln(1 + \sqrt{1+1}) + \frac{4}{\sqrt{8}} \\ &= 4 \ln(1 + \sqrt{2}) + \frac{4\sqrt{8}}{\sqrt{8} \times \sqrt{8}} \\ &= 4 \ln(1 + \sqrt{2}) + \frac{4\sqrt{8}}{8} \\ &= 4 \ln(1 + \sqrt{2}) + \frac{\sqrt{8}}{2} \\ &= 4 \ln(1 + \sqrt{2}) + \sqrt{2}. \end{aligned}$$

**Exercise 6I**

1. Differentiate the following:

- (a)  $\tanh^{-1} \frac{x}{3}$ ,      (b)  $\sinh^{-1} \frac{x}{3}$ ,      (c)  $\cosh^{-1} \frac{x}{4}$ ,  
 (d)  $e^x \sinh^{-1} x$ ,      (e)  $\frac{1}{x} \cosh^{-1} x^2$ .

2. If  $y = x \cosh^{-1} x$ , find  $\frac{dy}{dx}$  when  $x = 2$ , giving your answer in the form  $a + \ln b$ , where  $a$  and  $b$  are irrational numbers.

## 6.11 Integrals which integrate to inverse hyperbolic functions

Integration can be regarded as the reverse of differentiation so it follows, from the results in Section 6.10, that:

$$\int \frac{dx}{\sqrt{a^2 + x^2}} = \sinh^{-1} \frac{x}{a} + c$$

$$\int \frac{dx}{\sqrt{x^2 - a^2}} = \cosh^{-1} \frac{x}{a} + c$$

$$\int \frac{dx}{\sqrt{a^2 - x^2}} = \frac{1}{a} \tanh^{-1} \frac{x}{a} + c$$

The integrals of  $\frac{1}{\sqrt{a^2 + x^2}}$  and  $\frac{1}{\sqrt{x^2 - a^2}}$ , in particular, help to widen the ability to integrate.

In fact, these results can be used to integrate any expression of the form  $\frac{1}{\sqrt{px^2 + qx + r}}$ , or

even  $\frac{sx + t}{\sqrt{px^2 + qx + r}}$ , where  $p > 0$ . The examples which follow show how this can be done.

### Example 6.11.1

Find  $\int \frac{dx}{\sqrt{16 + x^2}}$ .

#### Solution

$$\int \frac{dx}{\sqrt{16 + x^2}} = \int \frac{dx}{\sqrt{4^2 + x^2}}$$

$$= \sinh^{-1} \left( \frac{x}{4} \right) + c.$$

**Example 6.11.2**

Find  $\int \frac{dx}{\sqrt{6+2x^2}}$ .

**Solution**

$$\begin{aligned} \int \frac{dx}{\sqrt{6+2x^2}} &= \int \frac{dx}{\sqrt{2(3+x^2)}} \\ &= \frac{1}{\sqrt{2}} \int \frac{dx}{\sqrt{3+x^2}} \\ &= \frac{1}{\sqrt{2}} \sinh^{-1} \left( \frac{x}{\sqrt{3}} \right) + c. \end{aligned}$$

**Example 6.11.3**

Find  $\int \frac{dx}{\sqrt{x^2+2x-3}}$ .

**Solution**

In order to evaluate this integral, you must complete the square in the denominator.

$$\begin{aligned} x^2 + 2x - 3 &= (x^2 + 2x + 1) - 4 \\ &= (x+1)^2 - 4. \end{aligned}$$

Hence, 
$$\int \frac{dx}{\sqrt{x^2+2x-3}} = \int \frac{dx}{\sqrt{(x+1)^2-4}}.$$

Substituting  $z = x+1$ , for which  $dz = dx$ , gives

$$\begin{aligned} \int \frac{dx}{\sqrt{x^2+2x-3}} &= \int \frac{dz}{z^2-4} \\ &= \cosh^{-1} \left( \frac{z}{2} \right) + c \\ &= \cosh^{-1} \left( \frac{x+1}{2} \right) + c. \end{aligned}$$

**Example 6.11.4**

Find  $\int \frac{2x+5}{\sqrt{x^2+6x+10}} dx$ .

**Solution**

In this case, the integral is split into two by writing one integral with a numerator which is the derivative of  $x^2+6x+10$ .

Now,  $\frac{d}{dx}(x^2+6x+10) = 2x+6$ .

But  $2x+5 = 2x+6-1$

and 
$$\int \frac{2x+5}{\sqrt{x^2+6x+10}} dx = \int \frac{2x+6}{\sqrt{x^2+6x+10}} dx - \int \frac{1}{\sqrt{x^2+6x+10}} dx.$$

$$= I_1 - I_2, \quad \text{say.}$$

Because the derivative of  $x^2+6x+10$  is  $2x+6$ , then for  $I_1$  the substitution  $z = x^2+6x+10$  gives  $\frac{dz}{dx} = 2x+6$  and consequently

$$\begin{aligned} I_1 &= \int \frac{dz}{\sqrt{z}} \\ &= \int z^{-\frac{1}{2}} dz \\ &= \frac{z^{\frac{1}{2}}}{\frac{1}{2}} \\ &= 2\sqrt{x^2+6x+10}. \end{aligned}$$

For  $I_2$ , completing the square in the denominator,

$$\begin{aligned} x^2+6x+10 &= x^2+6x+9+1 \\ &= (x+3)^2+1. \end{aligned}$$

So that 
$$I_2 = \int \frac{dx}{(x+3)^2+1}.$$

The substitution  $u = x+3$  will give  $\frac{du}{dx} = 1$ ,

and 
$$\begin{aligned} I_2 &= \int \frac{du}{\sqrt{u^2+1}} \\ &= \sinh^{-1} u \\ &= \sinh^{-1}(x+3). \end{aligned}$$

Therefore, the complete integral is

$$I_1 - I_2 = 2\sqrt{x^2+6x+10} - \sinh^{-1}(x+3) + c.$$

**Exercise 6J**

1. Evaluate the following integrals:

(a)  $\int \frac{dx}{\sqrt{x^2 + 9}},$

(b)  $\int \frac{dx}{\sqrt{x^2 - 16}},$

(c)  $\int \frac{dx}{\sqrt{4x^2 + 25}},$

(d)  $\int \frac{dx}{\sqrt{9x^2 + 49}},$

(e)  $\int \frac{dx}{\sqrt{(x+1)^2 + 4}},$

(f)  $\int \frac{dx}{\sqrt{(x-2)^2 - 16}},$

(g)  $\int \frac{dx}{\sqrt{x^2 + 4x + 5}},$

(h)  $\int \frac{dx}{\sqrt{x^2 - 2x - 2}}.$

**6.12 Solving equations**

You are likely to meet two types of equations involving hyperbolic functions. The methods for solving them are quite different.

The first type has the form  $a \cosh x + b \sinh x = c$ , or a similar linear combination of hyperbolic functions. The correct method for solving this type of equation is to use the definitions of  $\sinh x$  and  $\cosh x$  to turn the equation into one involving  $e^x$  (frequently a quadratic equation).

**Example 6.12.1**

Solve the equation  $7 \sinh x - 5 \cosh x = -1$ .

**Solution**

Using the definitions  $\sinh x = \frac{e^x - e^{-x}}{2}$  and  $\cosh x = \frac{e^x + e^{-x}}{2}$ ,

$$7 \left( \frac{e^x - e^{-x}}{2} \right) - 5 \left( \frac{e^x + e^{-x}}{2} \right) = -1$$

$$\frac{7e^x}{2} - \frac{7e^{-x}}{2} - \frac{5e^x}{2} - \frac{5e^{-x}}{2} = -1$$

$$e^x - 6e^{-x} = -1.$$

Multiplying throughout by  $e^x$ ,

$$e^{2x} - 6 = -e^x,$$

or  $e^{2x} + e^x - 6 = 0$ .

This is a quadratic equation in  $e^x$  and factorizes to

$$(e^x + 3)(e^x - 2) = 0.$$

Hence,  $e^x = -3$  or  $e^x = 2$ . The only solution possible is  $x = \ln 2$  because  $e^x \neq -3$  since  $e^x > 0$  for all values of  $x$ .

**Example 6.12.2**

Solve the equation  $\cosh^2 x = 4 \sinh x + 6$ .

**Solution**

The identity  $\cosh^2 x - \sinh^2 x = 1$  is used here. The reason for this can be seen on substitution – instead of having an equation involving  $\cosh x$  and  $\sinh x$ , the original equation is reduced to one involving  $\sinh x$  only.

$$1 + \sinh^2 x = 4 \sinh x + 6$$

$$\sinh^2 x - 4 \sinh x - 5 = 0.$$

This is a quadratic equation in  $\sinh x$  which factorizes to

$$(\sinh x - 5)(\sinh x + 1) = 0.$$

Hence,

$$\sinh x = 5 \text{ or } \sinh x = -1$$

and

$$x = \sinh^{-1} 5 \text{ or } x = \sinh^{-1} -1,$$

and

$$x = 2.31 \text{ or } x = -0.88 \quad (\text{to two decimal places}).$$

The answers can also be expressed in terms of logarithms, using the results from Section 5.9:

$$\sinh^{-1} 5 = \ln\left(5 + \sqrt{5^2 + 1}\right) = \ln\left(5 + \sqrt{26}\right);$$

$$\sinh^{-1} -1 = \ln\left(-1 + \sqrt{(-1)^2 + 1}\right) = \ln\left(\sqrt{2} - 1\right).$$

Note that it is not advisable to use the definitions of  $\sinh x$  and  $\cosh x$  when attempting to solve the equation in Example 5.12.2 – this would generate a quartic equation in  $e^x$  which would be difficult to solve.

**Examples 6K**

1. Solve the equations:

(a)  $4 \sinh x + 3e^x = 9$ ,

(b)  $3 \sinh x + 4 \cosh x = 4$ ,

(c)  $\cosh^2 x - 3 \sinh x = 5$ ,

(d)  $\cosh 2x - 3 \cosh x = 4$ ,

(e)  $\tanh^2 x = 7 \operatorname{sech} x + 3$ .

**Miscellaneous exercises 6**

1. (a) Express  $\cosh x + \sinh x$  in terms of  $e^x$ .

(b) Hence evaluate  $\int_0^{\infty} \frac{1}{\cosh x + \sinh x} dx$ .

[AQA March 1999]

2. (a) Using the definitions

$$\cosh x = \frac{1}{2}(e^x + e^{-x}) \quad \text{and} \quad \sinh x = \frac{1}{2}(e^x - e^{-x}),$$

prove that

$$2 \sinh x \cosh x = \sinh 2x.$$

(b) Hence, or otherwise, solve the equation

$$8 \sinh x = 3 \operatorname{sech} x,$$

leaving your answer in terms of natural logarithms.

[AEB January 1997]

3. (a) By considering  $\sinh y = x$ , or otherwise, prove that

$$\sinh^{-1} x = \ln(x + \sqrt{1 + x^2}).$$

(b) Solve the equation

$$2 \cosh 2\theta - 5 \sinh \theta - 8 = 0,$$

leaving your answers in terms of natural logarithms.

[AEB January 1996]

4. (a) Show that the equation

$$14 \sinh x - 10 \cosh x = 5$$

can be expressed as

$$2e^{2x} - 5e^x - 12 = 0.$$

(b) Hence solve the equation

$$14 \sinh x - 10 \cosh x = 5,$$

giving your answer as a natural logarithm.

[AQA June 2001]

5. (a) Starting from the definition of  $\cosh t$  in terms of  $e^t$ , show that

$$4 \cosh^3 t - 3 \cosh t = \cosh 3t.$$

(b) Hence show that the substitution  $x = \cosh t$  transforms the equation

$$16x^3 - 12x = 5$$

into 
$$\cosh 3t = \frac{5}{4}.$$

(c) The above equation in  $x$  has only one real root. Obtain this root, giving your answer in the form  $2^p + 2^q$ , where  $p$  and  $q$  are rational numbers to be found.

[AQA March 1999]

6. (a) Using the definitions of  $\sinh \theta$  and  $\cosh \theta$  in terms of exponentials, show that

$$\tanh \theta = \frac{e^{2\theta} - 1}{e^{2\theta} + 1}.$$

(b) Hence prove that

$$\tanh^{-1} x = \frac{1}{2} \ln \left( \frac{1+x}{1-x} \right),$$

where  $-1 < x < 1$ .

[AEB June 1999]

7. (a) By expressing  $\tanh x$  in terms of  $\sinh x$  and  $\cosh x$ , show that

(i)  $\tanh^2 x = 1 - \operatorname{sech}^2 x,$

(ii)  $\frac{d}{dx} \tanh x = \operatorname{sech}^2 x.$

(b) (i) Find  $\int (\tanh x - \tanh^3 x) dx.$

(ii) Hence, or otherwise, find  $\int \tanh^3 x dx.$

[AQA March 2000]



8. (a) Explain, by means of a sketch, why the numbers of distinct values of  $x$  satisfying the equation

$$\cosh x = k$$

in the cases  $k < 1$ ,  $k = 1$  and  $k > 1$  are 0, 1 and 2, respectively.

(b) Given that  $\cosh x = \frac{17}{8}$  and  $\sinh y = \frac{4}{3}$ ,

- (i) express  $y$  in the form  $\ln n$ , where  $n$  is an integer,  
 (ii) show that one of the possible values of  $x + y$  is  $\ln 12$  and find the other possible value in the form  $\ln a$ , where  $a$  is to be determined.

[AQA March 2000]

9. (a) State the values of  $x$  for which  $\cosh^{-1} x$  is defined.

- (b) A curve  $C$  is defined for these values of  $x$  by the equation

$$y = x - \cosh^{-1} x.$$

- (i) Show that  $C$  has just one stationary point.  
 (ii) Evaluate  $y$  at the stationary point, giving your answer in the form  $p - \ln q$ , where  $p$  and  $q$  are numbers to be determined.

[NEAB March 1998]

10. (a) Prove that

$$\frac{d}{dx}(\tanh x) = \operatorname{sech}^2 x.$$

- (b) Hence, or otherwise, prove that

$$\frac{d}{dx}(\tanh^{-1} x) = \frac{1}{1-x^2}.$$

- (c) By expressing  $\frac{1}{1-x^2}$  in partial fractions and integrating, show that

$$\tanh^{-1} x = \frac{1}{2} \ln \left( \frac{1+x}{1-x} \right).$$

- (d) Show that

$$\int_0^{\frac{1}{2}} \frac{\tanh^{-1} x}{1-x^2} dx = a(\ln b)^2,$$

where  $a$  and  $b$  are numbers to be determined.

[AQA June 1990]

11. The diagram shows a region  $R$  in the  $x$ - $y$  plane bounded by the curve  $y = \sinh x$ , the  $x$ -axis and the line  $AB$  which is perpendicular to the  $x$ -axis.

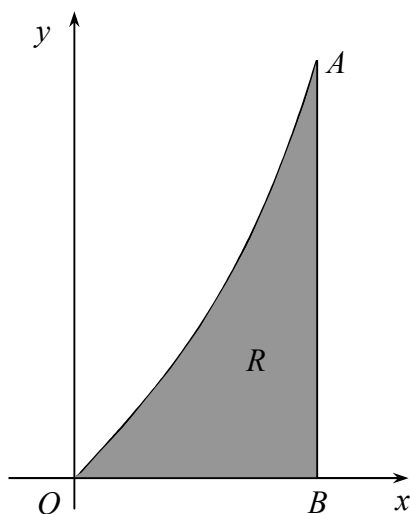

- (a) Given that  $AB = \frac{3}{4}$ , show that  $OB = \ln 3$ .
- (b) (i) Show that  $\cosh(\ln k) = \frac{k^2 + 1}{2k}$ .
- (ii) Show that the area of the region  $R$  is  $\frac{2}{3}$ .
- (c) (i) Show that  $\int_0^{\ln 3} \sinh^2 x \, dx = \frac{1}{4} [\sinh(\ln 9) - \ln 9]$ .
- (ii) Hence find, correct to three significant figures, the volume swept out when the region  $R$  is rotated through an angle of  $2\pi$  radians about the  $x$ -axis.

[NEAB June 1998]

## Chapter 7: Arc Length and Area of Surface of Revolution

7.1 Introduction

7.2 Arc length

7.3 Area of surface of revolution

---

---

This chapter introduces formulae which allow calculations concerning curves. When you have completed it, you will:

- know a formula which can be used to evaluate the length of an arc when the equation of the curve is given in Cartesian form;
- know a formula which can be used to evaluate the length of an arc when the equation of the curve is given in parametric form;
- know methods of evaluating a curved surface area of revolution when the equation of the curve is given in Cartesian or in parametric form.

## 7.1 Introduction

You will probably already be familiar with some formulae to do with the arc length of a curve and the area of surface of revolution. For example, the area under the curve

$y = f(x)$  above the  $x$ -axis and between the lines  $x = a$

and  $x = b$  is given by  $A = \int_a^b y \, dx$ .

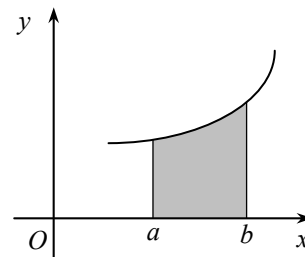

You will also be familiar with the formula  $V = \int_a^b \pi y^2 \, dx$  which gives the volume of the solid of revolution when that part of the curve between the lines  $x = a$  and  $x = b$  is rotated about the  $x$ -axis.

The formulae to be introduced in this chapter should be committed to memory. You should also realise that, as with many problems, the skills needed to solve them do not concern the formulae themselves but involve integration, differentiation and manipulation of algebraic, trigonometric and hyperbolic functions – many of which have been introduced in earlier chapters.

## 7.2 Arc length

The arc length of a curve is the actual distance you would cover if you travelled along it. In the diagram alongside,  $\delta s$  is the arc length between the points  $P$  and  $Q$  on the curve  $y = f(x)$ . If  $P$  has the coordinates  $(x, y)$ ,  $Q$  has coordinates  $(x + \delta x, y + \delta y)$  and  $PN$  is parallel to the  $x$ -axis so that angle  $PNQ$  is  $90^\circ$ , it follows that  $PN = \delta x$  and  $QN = \delta y$ .

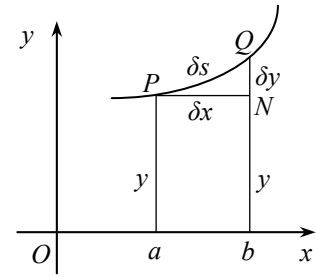

Now, if  $P$  and  $Q$  are fairly close to each other then the arc length  $\delta s$  must be quite short and  $PNQ$  be approximately a right-angled triangle. Using Pythagoras' theorem,

$$(\delta s)^2 \approx (\delta x)^2 + (\delta y)^2.$$

Dividing by  $(\delta x)^2$ ,

$$\left(\frac{\delta s}{\delta x}\right)^2 \approx 1 + \left(\frac{\delta y}{\delta x}\right)^2.$$

In the limit as  $\delta x \rightarrow 0$ ,

$$\left(\frac{ds}{dx}\right)^2 = 1 + \left(\frac{dy}{dx}\right)^2$$

$$\frac{ds}{dx} = \sqrt{1 + \left(\frac{dy}{dx}\right)^2}.$$

Thus,

$$s = \int_a^b \sqrt{1 + \left(\frac{dy}{dx}\right)^2} dx.$$

If  $y = f(x)$ , the length of the arc of curve from the point where  $x = a$  to the point where  $x = b$  is given by

$$s = \int_a^b \sqrt{1 + \left(\frac{dy}{dx}\right)^2} dx$$

A corresponding formula for curves given in terms of a parameter can also be derived. Suppose that  $x$  and  $y$  are both functions of a parameter  $t$ . As before,

$$(\delta s)^2 \approx (\delta x)^2 + (\delta y)^2.$$

Dividing by  $(\delta t)^2$ ,

$$\left(\frac{\delta s}{\delta t}\right)^2 \approx \left(\frac{\delta x}{\delta t}\right)^2 + \left(\frac{\delta y}{\delta t}\right)^2.$$

As  $\delta x \rightarrow 0$ ,  $\delta t \rightarrow 0$  and

$$\left(\frac{ds}{dt}\right)^2 = \left(\frac{dx}{dt}\right)^2 + \left(\frac{dy}{dt}\right)^2$$

$$\frac{ds}{dt} = \sqrt{\left(\frac{dx}{dt}\right)^2 + \left(\frac{dy}{dt}\right)^2}$$

$$s = \int_{t_1}^{t_2} \sqrt{\left(\frac{dx}{dt}\right)^2 + \left(\frac{dy}{dt}\right)^2} dt,$$

where  $t_1$  and  $t_2$  are the values of the parameter at each end of the arc length being considered.

The length of arc of a curve in terms of a parameter  $t$  is given by

$$s = \int_{t_1}^{t_2} \sqrt{\left(\frac{dx}{dt}\right)^2 + \left(\frac{dy}{dt}\right)^2} dt,$$

where  $t_1$  and  $t_2$  are the values of the parameter at each end of the arc

The use of these formulae will be demonstrated through some worked examples.

**Example 7.2.1**

Find the length of the curve  $y = \cosh x$  between the points where  $x = 0$  and  $x = 2$ .

**Solution**

$$y = \cosh x$$

$$\frac{dy}{dx} = \sinh x.$$

Therefore,  $1 + \left(\frac{dy}{dx}\right)^2 = 1 + \sinh^2 x$

$$= \cosh^2 x$$

$$\sqrt{1 + \left(\frac{dy}{dx}\right)^2} = \cosh x.$$

Now,

$$s = \int_0^2 \sqrt{1 + \left(\frac{dy}{dx}\right)^2} dx$$

$$= \int_0^2 \cosh x dx$$

$$= [\sinh x]_0^2$$

$$= \sinh 2 - \sinh 0$$

$$= \sinh 2.$$

**Example 7.2.2**

Show that the length of the curve (called a cycloid) given by the equations  $x = a(\theta - \sin \theta)$ ,  $y = a(1 - \cos \theta)$  between  $\theta = 0$  and  $\theta = 2\pi$  is  $8a$ .

**Solution**

$$\frac{dx}{d\theta} = a(1 - \cos \theta)$$

$$\frac{dy}{d\theta} = a \sin \theta.$$

Therefore,

$$\begin{aligned} \left(\frac{dx}{d\theta}\right)^2 + \left(\frac{dy}{d\theta}\right)^2 &= a^2(1 - \cos \theta)^2 + a^2 \sin^2 \theta \\ &= a^2(1 - 2\cos \theta + \cos^2 \theta + \sin^2 \theta) \\ &= a^2(1 - 2\cos \theta + 1) && \text{(using } \sin^2 \theta + \cos^2 \theta = 1) \\ &= a^2(2 - 2\cos \theta) \\ &= 2a^2(1 - \cos \theta) \\ &= 2a^2 \cdot 2 \sin^2 \frac{\theta}{2} && \text{(using } 2 \sin^2 \theta = 1 - \cos 2\theta) \\ \sqrt{\left(\frac{dx}{d\theta}\right)^2 + \left(\frac{dy}{d\theta}\right)^2} &= \sqrt{4a^2 \sin^2 \frac{\theta}{2}} \\ &= 2a \sin \frac{\theta}{2}. \end{aligned}$$

Now,

$$\begin{aligned} s &= \int_0^{2\pi} \sqrt{\left(\frac{dx}{d\theta}\right)^2 + \left(\frac{dy}{d\theta}\right)^2} d\theta \\ &= \int_0^{2\pi} 2a \sin \frac{\theta}{2} d\theta \\ &= \left[ 2a \left(-2\cos \frac{\theta}{2}\right) \right]_0^{2\pi} \\ &= -4a \cos \pi - (-4a \cos 0) \\ &= 8a. \end{aligned}$$



### 7.3 Area of surface of revolution

If an arc of a curve is rotated about an axis, it forms a surface. The area of this surface is known as the ‘curved surface area’ or ‘area of surface of revolution’.

Suppose two closely spaced points,  $P$  and  $Q$ , are taken on the curve  $y = f(x)$ . This arc is rotated about the  $x$ -axis by  $2\pi$  radians. The coordinates of  $P$  and  $Q$  are  $(x, y)$  and  $(x + \delta x, y + \delta y)$ , respectively, and the length of arc  $PQ$  is  $\delta s$ .

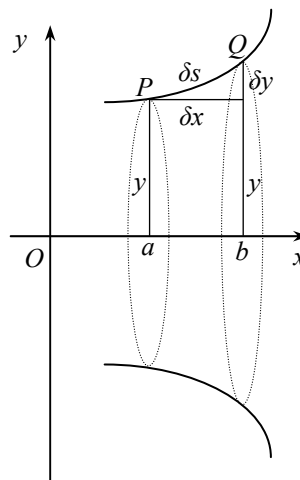

You can see from the diagram that the curved surface generated by the rotation is larger than that of the cylinder of width  $\delta s$  obtained by rotating the point  $P$  about the  $x$ -axis, but smaller than the area of the cylinder width  $\delta s$  obtained by rotating the point  $Q$  about the same axis. Using the formula  $S = 2\pi rh$  for the area of the curved surface of a cylinder, the area of the former is  $2\pi y \delta s$  and that of the latter

is  $2\pi(y + \delta y) \delta s$ . If the actual area generated by the rotation of arc  $PQ$  about the  $x$ -axis is denoted by  $\delta A$ , it follows that

$$2\pi y \delta s < \delta A < 2\pi(y + \delta y) \delta s$$

or, dividing by  $\delta s$ ,

$$2\pi y < \frac{\delta A}{\delta s} < 2\pi(y + \delta y).$$

Now as  $\delta x \rightarrow 0$ ,  $\delta y \rightarrow 0$  and  $\delta s \rightarrow 0$  so that the right-hand side of the inequality tends to  $2\pi y$ . Therefore,

$$\frac{dA}{ds} = 2\pi y$$

$$A = \int_a^b 2\pi y \, ds$$

$$= \int_a^b 2\pi y \sqrt{1 + \left(\frac{dy}{dx}\right)^2} \, dx \quad \text{(from section 6.2)}$$

The area of surface of revolution obtained by rotating an arc of the curve  $y = f(x)$  through  $2\pi$  radians about the  $x$ -axis between the points where  $x = a$  and  $x = b$  is given by

$$A = \int_a^b 2\pi y \sqrt{1 + \left(\frac{dy}{dx}\right)^2} \, dx$$

**Example 7.3.1**

Find the area of surface of revolution when the curve  $y = \cosh x$  is rotated through  $2\pi$  radians about the  $x$ -axis.

**Solution**

This was the curve used in example 6.2.1 – from there

$$\sqrt{1 + \left(\frac{dy}{dx}\right)^2} = \cosh x.$$

Hence,

$$\begin{aligned} A &= \int_0^2 2\pi y \sqrt{1 + \left(\frac{dy}{dx}\right)^2} dx \\ &= \int_0^2 2\pi \cosh x \cosh x dx \\ &= 2\pi \int_0^2 \cosh^2 x dx \\ &= 2\pi \int_0^2 \frac{1}{2}(1 + \cosh 2x) dx \\ &= \pi \left[ x + \frac{\sinh 2x}{2} \right]_0^2 \\ &= \pi \left[ 2 + \frac{1}{2} \sinh 4 \right] - \pi \left[ 0 + \frac{1}{2} \sinh 0 \right] \\ &= \pi \left[ 2 + \frac{1}{2} \sinh 4 \right]. \end{aligned}$$

**Example 7.3.2**

Show that the area of surface of revolution when the cycloid curve given by the equations  $x = a(\theta - \sin \theta)$ ,  $y = a(1 - \cos \theta)$  is rotated through  $2\pi$  radians about the  $x$ -axis is  $\frac{64}{3}\pi a^2$ .

**Solution**

This was the curve used in example 6.2.2 – from there

$$\sqrt{\left(\frac{dx}{d\theta}\right)^2 + \left(\frac{dy}{d\theta}\right)^2} = 2a \sin \frac{\theta}{2}.$$

Now,

$$\begin{aligned} A &= \int_0^{2\pi} 2\pi y \sqrt{\left(\frac{dx}{d\theta}\right)^2 + \left(\frac{dy}{d\theta}\right)^2} d\theta \\ &= \int_0^{2\pi} 2\pi a(1 - \cos \theta) 2a \sin \frac{\theta}{2} d\theta \\ &= 4\pi a^2 \int_0^{2\pi} \left\{1 - \left(2 \cos^2 \frac{\theta}{2} - 1\right)\right\} \sin \frac{\theta}{2} d\theta \quad (\text{using } \cos 2x = 2 \cos^2 x - 1) \\ &= 4\pi a^2 \int_0^{2\pi} \left(2 \sin \frac{\theta}{2} - 2 \cos^2 \frac{\theta}{2} \sin \frac{\theta}{2}\right) d\theta \\ &= 8\pi a^2 \int_0^{2\pi} \left(\sin \frac{\theta}{2} - \cos^2 \frac{\theta}{2} \sin \frac{\theta}{2}\right) d\theta. \end{aligned}$$

Now, consider  $\int \cos^2 \frac{\theta}{2} \sin \frac{\theta}{2} d\theta$ . The substitution  $u = \cos \frac{\theta}{2}$  gives

$$du = -\frac{1}{2} \sin \frac{\theta}{2} d\theta$$

and the integral becomes

$$\begin{aligned} \int u^2 (-2du) &= -\frac{2u^3}{3} \\ &= -\frac{2 \cos^3 \frac{\theta}{2}}{3}. \end{aligned}$$

Integrating for  $A$ ,

$$\begin{aligned} A &= 8\pi a^2 \left[ -2 \cos \frac{\theta}{2} + \frac{2}{3} \cos^3 \frac{\theta}{2} \right]_0^{2\pi} \\ &= 8\pi a^2 \left\{ \left[ -2 \cos \pi + \frac{2}{3} \cos^3 \pi \right] - \left[ -2 \cos 0 + \frac{2 \cos^3 0}{3} \right] \right\} \\ &= 8\pi a^2 \left[ 2 - \frac{2}{3} + 2 - \frac{2}{3} \right] \\ &= \frac{64}{3} \pi a^2. \end{aligned}$$

**Miscellaneous exercises 7**

1. (a) Show that

(i)  $\frac{d}{d\theta}(\tan \theta) = \operatorname{sech}^2 \theta,$

(ii)  $\frac{d}{d\theta}(\operatorname{sech} \theta) = -\operatorname{sech} \theta \tanh \theta.$

(b) A curve  $C$  is given parametrically by

$$x = \theta - \tanh \theta, \quad y = \operatorname{sech} \theta, \quad \theta \geq 0.$$

(i) Show that  $\left(\frac{dx}{d\theta}\right)^2 + \left(\frac{dy}{d\theta}\right)^2 = \tanh^2 \theta.$

(ii) The length of arc  $C$  measured from the point  $(0,1)$  to a general point with parameter  $\theta$  is  $s$ . Find  $s$  in terms of  $\theta$  and deduce that, for any point on curve,  $y = e^{-s}$ .

[AQA Specimen]

2. (a) Using only the definitions of  $\cosh x$  and  $\sinh x$  in terms of exponentials,

(i) determine the exact values of  $\cosh \alpha$  and  $\sinh \alpha$ , where  $\alpha = \ln \frac{9}{4}$ ,

(ii) establish the identities

$$\cosh 2x \equiv 2 \cosh^2 x - 1$$

$$\sinh 2x \equiv 2 \sinh x \cosh x.$$

(b) The arc of the curve with equation  $y = \cosh x$ , between the points where  $x = 0$  and  $x = \ln \frac{9}{4}$ , is rotated through one full turn about the  $x$ -axis to form a surface of revolution with area  $S$ . Show that

$$S = \pi \left( \ln \frac{9}{4} + p \right)$$

for some rational number  $p$  whose value you should state.

[AEB June 2000]

3. (a) (i) Using only the definitions

$$\cosh \theta = \frac{1}{2}(e^\theta + e^{-\theta}) \text{ and } \sinh \theta = \frac{1}{2}(e^\theta - e^{-\theta}),$$

prove the identity

$$\cosh^2 \theta - \sinh^2 \theta = 1.$$

(ii) Deduce a relationship between  $\operatorname{sech} \theta$  and  $\tanh \theta$ .

(b) A curve C has parametric representation  $x = \operatorname{sech} \theta$ ,  $y = \tanh \theta$ .

(i) Show that  $\left(\frac{dx}{d\theta}\right)^2 + \left(\frac{dy}{d\theta}\right)^2 = \operatorname{sech}^2 \theta$ .

(ii) The arc of the curve between the points where  $\theta = 0$  and  $\theta = \ln 7$  is rotated through one full turn about the  $x$ -axis. Show that the area of the surface generated is  $\frac{36}{25}\pi$  square units.

[AEB June 1997]

4. A curve has parametric representation

$$x = \theta + \sin \theta, \quad y = 1 + \cos \theta, \quad 0 \leq \theta \leq 2\pi.$$

(a) Prove that  $\left(\frac{dx}{d\theta}\right)^2 + \left(\frac{dy}{d\theta}\right)^2 = 4\cos^2 \frac{\theta}{2}$ .

(b) The arc of this curve, between the points when  $\theta = 0$  and  $\theta = \frac{\pi}{2}$  is rotated about the  $x$ -axis through  $2\pi$  radians. The area of the surface generated is denoted by  $S$ . Determine the value of the constant  $k$  for which

$$S = k \int_0^{\frac{\pi}{2}} \left(1 - \sin^2 \frac{\theta}{2}\right) \cos \frac{\theta}{2} d\theta,$$

and hence evaluate  $S$  exactly.

[AEB June 1996]

5. The curve  $C$  is defined parametrically by the equations

$$x = \frac{1}{3}t^3 - t, \quad y = t^2,$$

where  $t$  is a parameter.

(a) Show that  $\left(\frac{dx}{dt}\right)^2 + \left(\frac{dy}{dt}\right)^2 = (t^2 + 1)^2$ .

(b) The arc of  $C$  between the points where  $t = 0$  and  $t = 3$  is denoted by  $L$ . Determine

(i) the length of  $L$ ,

(ii) the area of the surface generated when  $L$  is rotated through  $2\pi$  radians about the  $x$ -axis

[AEB January 1998]

6. (a) Given that  $a$  is a positive constant and that

$$y = a^2 \sinh^{-1}\left(\frac{x}{a}\right) + x\sqrt{a^2 + x^2},$$

use differentiation to determine the value of the constant  $k$  for which

$$\frac{dy}{dx} = k\sqrt{a^2 + x^2}.$$

(b) A curve has the equation  $y = \sinh^{-1} x + x\sqrt{1 + x^2}$ . The length of the arc of curve between the points where  $x = 0$  and  $x = 1$  is denoted by  $L$ . Show that

$$L = \frac{5 \ln 5 + 12}{8}.$$

[AEB January 2000]

**Answers to Exercises – Further Pure 2****Chapter 1****Exercise 1A**

1. (a)  $\sqrt{2}, -\frac{\pi}{4}$       (b)  $3, \frac{\pi}{2}$       (c)  $4, \pi$       (d)  $2, -\frac{5\pi}{6}$
2. (a) 3.16, 2.82      (b) 5, 0.93      (c) 7.07, -1.71

**Exercise 1B**

1. (a)  $\sqrt{2}\left(\cos-\frac{\pi}{4} + i\sin-\frac{\pi}{4}\right)$       (b)  $3\left(\cos\frac{\pi}{2} + i\sin\frac{\pi}{2}\right)$   
(c)  $4(\cos\pi + i\sin\pi)$       (d)  $2\left(\cos-\frac{5\pi}{6} + i\sin-\frac{5\pi}{6}\right)$
2. (a)  $-\sqrt{2} + \sqrt{2}i$       (b)  $-2 - 2\sqrt{3}i$

**Exercise 1C**

1. (a)  $3 + i, 4 + 3i$       (b)  $-1 + 8i, -14 + 2i$

**Exercise 1D**

1. (a)  $\frac{1}{5}(6 + 8i)$       (b)  $2 + 2i$

**Exercise 1E**

1. (a)  $\frac{2}{3}\left(\cos\frac{\pi}{2} + i\sin\frac{\pi}{2}\right)$       (b)  $\left|\frac{z_1}{z_2}\right| = \frac{|z_1|}{|z_2|}$  and  $\arg\left(\frac{z_1}{z_2}\right) = \arg z_1 - \arg z_2$

**Exercise 1F**

1. (a)  $\left(6, \frac{\pi}{2}\right)$       (b)  $\left(\frac{3}{2}, \frac{5\pi}{6}\right)$       (c)  $\left(9, \frac{4\pi}{3}\right)$   
 (d)  $(27, 0)$       (e)  $\left(\frac{2}{9}, \frac{-5\pi}{6}\right)$
2. (a)  $2.5 + 0.5i$       (b)  $4 + 2i$       (c)  $1 - \frac{1}{3}i$

**Exercise 1G**

1. (a) 5.39, 0.38      (b) 5, 0.93      (c) 7.62, -1.98

**Exercise 1H**

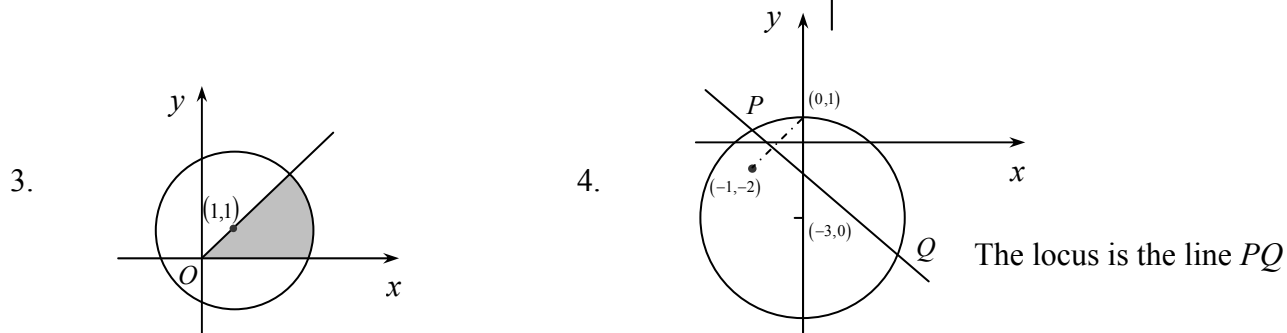
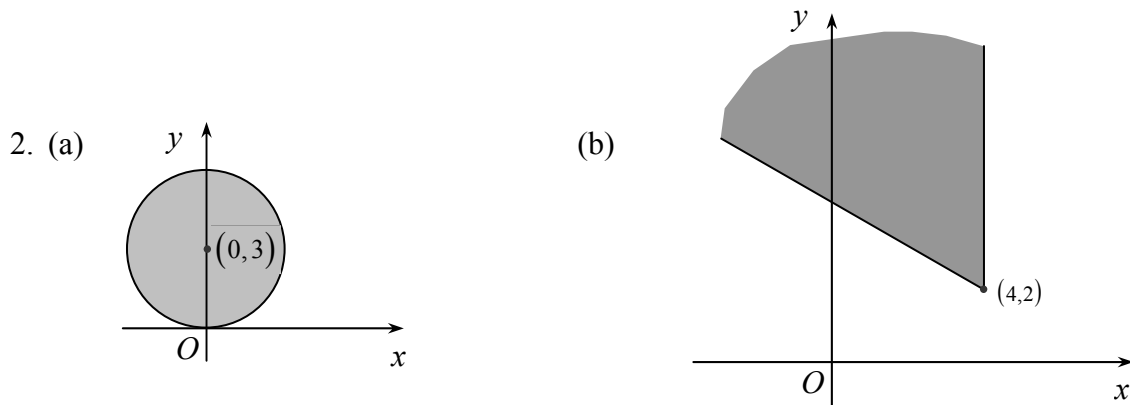
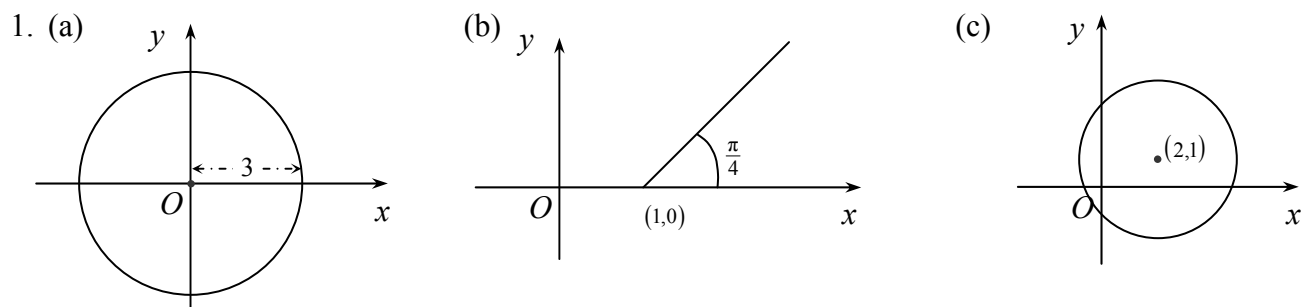



Miscellaneous exercises 1

1.  $3 - 2i$

2. (a)  $\frac{1}{5}(4 + 3i)$

(b)

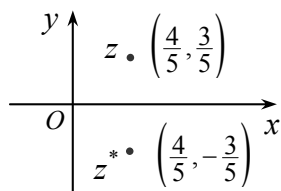

(c) 1, 1.2

3.  $1 - 2i, 4 - 2i$

4.  $\frac{1}{5}(1 - i)$

5. (a)

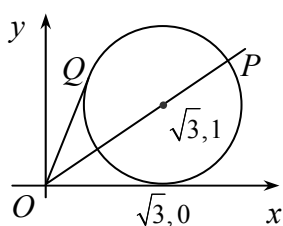

(b) 3

(c)  $\frac{\pi}{3}$

6.

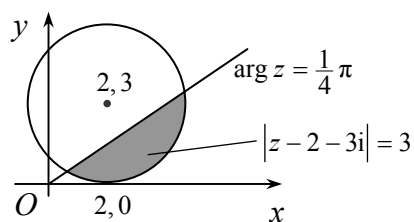

7. (a)(i)  $-1 + i$  (ii)  $\sqrt{2}, \frac{3\pi}{4}$

(b)(ii)

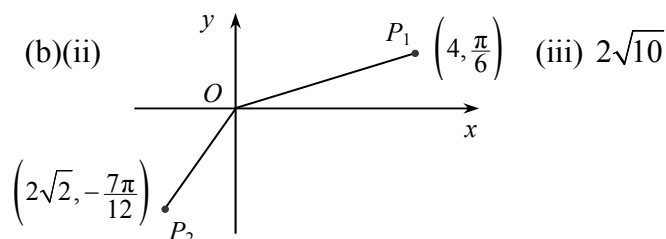

(iii)  $2\sqrt{10}$

8. (a)

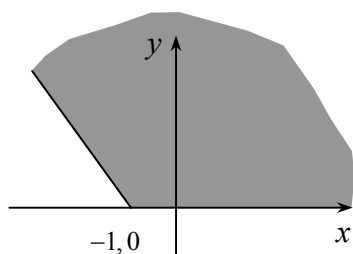

(b)

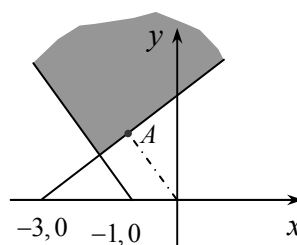

9. (a)  $14 + 2i, 1 + i$

(b)(i)  $\sqrt{20}, 0.46$  and  $\sqrt{10}, -0.32$  (ii)  $\sqrt{10}$

**Chapter 2****Exercise 2A**

1. (a)  $-3 \pm i$                       (b)  $-5 \pm i$

**Exercise 2B**

1. (a)  $-1, -1, 3$                       (b)  $1, 1 \pm i$                       (c)  $2, -2 \pm i$

**Exercise 2C**

1. (a)  $7, 12, -5$                       (b)  $\frac{-4}{3}, \frac{-7}{3}, \frac{-2}{3}$

2.  $2x^3 - 6x^2 + 7x + 10 = 0$

**Exercise 2D**

1&2 (a)  $x^3 - 3x^2 - 36x - 189 = 0$                       (b)  $x^3 - 4x^2 + x - 5 = 0$                       (c)  $7x^3 + 8x^2 + 4x - 8 = 0$

3. (a)  $2x^3 - 9x^2 + 162 = 0$                       (b)  $2x^3 - 9x^2 + 12x + 1 = 0$

**Exercise 2E**

1. (a)  $16x^4 - 6x^2 + 5x - 4 = 0$                       (b) 3

**Exercise 2F**

1.  $x^3 - 4x^2 + 6x - 4 = 0$

2.  $2, -3i$

3.  $1+i, \pm \frac{i}{2}$

**Miscellaneous exercises 2**

1. (a)  $\alpha = 1, \beta = \sqrt{5}$

(b)  $-2$

2. (b) (i)  $\beta = 3 - 4i, \gamma = -6$

(ii)  $-150$

(iii)  $0, -11, 150$

3. (a)  $\sum \alpha = 0 \quad \sum \alpha\beta = \frac{3}{2} \quad \alpha\beta\gamma = -2$

(b)  $2x^3 - 3x^2 - 8 = 0$

4. (a)  $\frac{8}{7}$

(b)  $1 - 2i, \frac{-6}{7}$

5. (a)  $p = -3$

(b) (i)  $q = 7$

(ii)  $\sum \alpha^2 < 0$

(c) (i)  $-3$

(ii)  $75$

6. (b) (i)  $p = 4, q = -4$

**Chapter 3****Exercise 3A**

1. (a)  $2r$                       (b)  $\frac{1}{2}n(n+1)$

2. (b)  $\frac{1}{18} - \frac{1}{3(n+1)(n+2)(n+3)}$

3. (b)  $\frac{1}{6}n(n+1)(n+2)$

**Miscellaneous exercises 3**

2. (b)  $n(n+1)(n^2+n+1)$

9. (a) 2

10. (a) 1                      (c) 1

### Chapter 4

#### Exercise 4A

2. (a)  $\cos 15\theta + i \sin 15\theta$       (b) 1      (c)  $i$       (d)  $-8i$   
 (e)  $-64$       (f)  $-\frac{1}{64}(\sqrt{3} + i)$       (g)  $-41472\sqrt{3}$

#### Exercise 4B

1.  $3 \sin \theta - 4 \sin^3 \theta$   
 2.  $\frac{3 \tan \theta - \tan^3 \theta}{1 - 3 \tan^2 \theta}$   
 3.  $16 \sin^5 \theta - 20 \sin^3 \theta + 5 \sin \theta$

#### Exercise 4C

1. (a)  $\frac{1}{2} \left( z^4 + \frac{1}{z^4} \right)$       (b)  $\frac{1}{2} \left( z^7 + \frac{1}{z^7} \right)$       (c)  $\frac{1}{2i} \left( z^6 - \frac{1}{z^6} \right)$       (d)  $\frac{1}{2i} \left( z^3 - \frac{1}{z^3} \right)$

#### Exercise 4D

1. (a)  $\sqrt{2}e^{\frac{\pi i}{4}}$       (b)  $2e^{-\frac{\pi i}{6}}$       (c)  $\sqrt{12}e^{\frac{\pi}{6}}$       (d)  $4e^{\frac{5\pi}{6}}$

#### Exercise 4E

1. (a)  $-1$       (b) 7      (c) 8

#### Exercise 4F

1. (a)  $\pm 1, \pm i$       (b)  $2 \left( \cos \frac{2k\pi}{5} + i \sin \frac{2k\pi}{5} \right), \quad k = 0 \pm 1, \pm 2$   
 (c)  $\cos \frac{k\pi}{5} + i \sin \frac{k\pi}{5}, \quad k = 0 \pm 1, \pm 2, \pm 3, \pm 4, 5$   
 2.  $\cos \frac{2k\pi}{5} + i \sin \frac{2k\pi}{5}, \quad k = \pm 1, \pm 2$   
 3.  $\frac{1}{2}, \pm \frac{1}{2}i$

**Exercise 4G**

1. (a)  $2e^{\frac{(1+2k)\pi}{8}}$   $k = 0, 1, 2, 3$       (b)  $2^{\frac{1}{6}}e^{\frac{(8k-1)\pi}{12}}$   $k = 1, 2, 3$   
 (c)  $2^{\frac{1}{8}}e^{\frac{(6k-1)\pi}{24}}$   $k = 1, 2, 3, \dots, 8$       (d)  $\pm \frac{1}{\sqrt{2}}(i-1)$   
 (e)  $2e^{\frac{(4k+1)\pi}{6}} - 1$   $k = 0, 1, 2$       (f)  $-\frac{1}{2}\left(\cot \frac{k\pi}{5} - i\right)$

**Miscellaneous exercises 4**

1. (a)  $64, +\pi$       (b)  $2\sqrt{2}\left(\cos \frac{\pi}{4} + i \sin \frac{\pi}{4}\right), 2\left(\cos -\frac{\pi}{6} + i \sin -\frac{\pi}{6}\right)$   $k = 0, \pm 1, 2$   
 (c)  $\pm 2(1+i), \pm 2(1-i)$   
 2. (a)  $\sqrt{2}\left(\cos \frac{\pi}{4} + i \sin \frac{\pi}{4}\right), 2\left(\cos -\frac{\pi}{6} + i \sin -\frac{\pi}{6}\right)$   
 (b)(ii)  $1.41 + 0.12i, -0.81 + 1.16i, -0.60 - 1.28i$

3. (b)  $\pm \sqrt{\frac{5 \pm \sqrt{5}}{8}}$       (c)  $\sqrt{\frac{5 - \sqrt{5}}{8}}, \sqrt{\frac{5 + \sqrt{5}}{8}}$

4. (b)  $1, 3$

5. (b)  $z = 1 + e^{\frac{\pi i(1+2k)}{5}}$   $k = \pm 1, \pm 2$       (c) centre  $z = 1$ , radius 1  
 (d)(i)  $\frac{\pi}{10}$       (ii)  $2 \cos \frac{\pi}{10}$

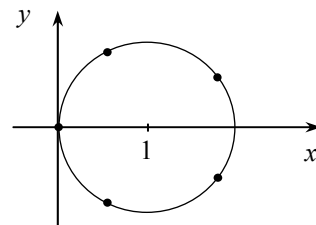

6. (b)(ii)  $x^2 + x - 1 = 0$       (iii)  $2 \cos \frac{2\pi}{5}, 2 \cos \frac{4\pi}{5}$       (iv)  $\frac{-1 + \sqrt{5}}{4}, \frac{-1 - \sqrt{5}}{4}$

7. (a)(ii)  $2i \sin n\theta$       (b)(i)  $A = 1, B = -3$

8. (a)(i)  $2 \sin \frac{\theta}{2}$       (b)  $e^{\frac{k\pi i}{3}}$   $k = \pm 1, \pm 2$

- (c)(i) coefficients of  $w^6$  cancel      (ii)  $-\frac{1}{2}$

9. (b)  $\sqrt{2}e^{\frac{3\pi i}{4}}, \sqrt{2}e^{\frac{7\pi i}{12}}$

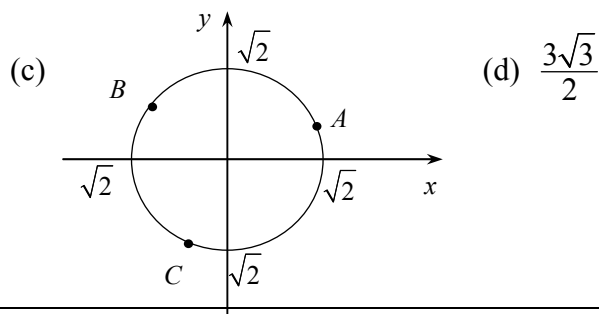

## Chapter 5

### Exercise 5A

1. (a)  $\frac{\pi}{4}$     (b)  $\frac{\pi}{6}$     (c)  $-\frac{\pi}{6}$     (d)  $\frac{\pi}{2}$     (e)  $\frac{-\pi}{6}$     (f)  $\pi$

### Exercise 5C

1. (a)  $\frac{3}{1+9x^2}$                       (b)  $\frac{-3}{\sqrt{6x-9x^2}}$                       (c)  $\frac{2}{\sqrt{1-4x^2}}$

2. (a)  $\frac{x}{1+x^2} + \tan^{-1} x$

(b)  $e^x \cos^{-1} 2x - \frac{2e^x}{\sqrt{1-4x^2}}$

(c)  $2x \sin^{-1}(2x-3) + \frac{2x^2}{\sqrt{-8+12x-4x^2}}$

3. (a)  $\frac{3}{x^3\sqrt{1-9x^2}} - \frac{3\sin^{-1} 3x}{x^4}$

(b)  $\frac{6x}{(1+x^2)\left(1+(3x^2+1)^2\right)} - \frac{2x \tan^{-1}(3x^2+1)}{(1+x^2)^2}$

4. (a)  $\frac{a}{\sqrt{1-(ax+b)^2}}$                       (b)  $\frac{a}{1+(ax+b)^2}$

**Exercise 5D**

- $\frac{\pi}{6}$
- $\pi$
- $\frac{\pi}{2}$  [note that  $\sin^{-1} \frac{4}{5} + \sin^{-1} \frac{3}{5} = \frac{\pi}{2}$  by drawing a 3, 4, 5 right-angled triangle].
- $\frac{\pi}{4}$
- $\frac{\pi}{2}$

**Exercise 5E**

- (a)  $\tan^{-1}(x+2)$       (b)  $\frac{1}{\sqrt{6}} \tan^{-1} \sqrt{\frac{2}{3}}(x-1)$       (c)  $\frac{2}{\sqrt{7}} \tan^{-1} \frac{2x-1}{\sqrt{7}}$
- (a)  $\ln(x^2 + 2x + 3) - \sqrt{2} \tan^{-1} \left( \frac{x+1}{\sqrt{2}} \right)$   
(b)  $\frac{1}{2} \ln(x^2 + x + 1) - \frac{1}{\sqrt{3}} \tan^{-1} \left( \frac{2x+1}{\sqrt{3}} \right)$
- (a)  $\sin^{-1} \left( \frac{x-3}{4} \right)$       (b)  $\sin^{-1} \left( \frac{x-1}{2} \right)$       (c)  $\frac{1}{\sqrt{2}} \sin^{-1}(4x-1)$
- (a)  $\sin^{-1} x - \sqrt{1-x^2}$   
(b)  $-3\sqrt{3+2x-x^2} + \sin^{-1} \left( \frac{x-1}{2} \right)$   
(c)  $\sqrt{1-x-x^2} + \frac{3}{2} \sin^{-1} \left( \frac{2x+1}{\sqrt{5}} \right)$



### Chapter 6

#### Exercise 6A

1. (a)  $\frac{2}{e^x + e^{-x}}$       (b)  $\frac{e^{2x} + 1}{e^{2x} - 1}$       (c)  $\frac{e^x - 1}{e^x + 1}$       (d)  $\frac{2}{e^{3x} - e^{-3x}}$

#### Exercise 6B

1. (a) 0.64      (b) 0.86      (c) 0.24      (d) -0.54      (e) 1.05      (f) 1.00

#### Exercise 6C

1. (a)

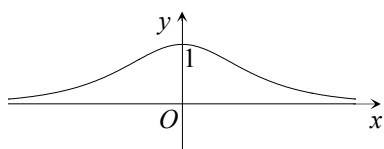

(b)

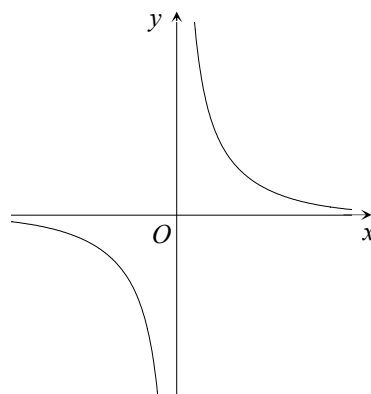

(c)

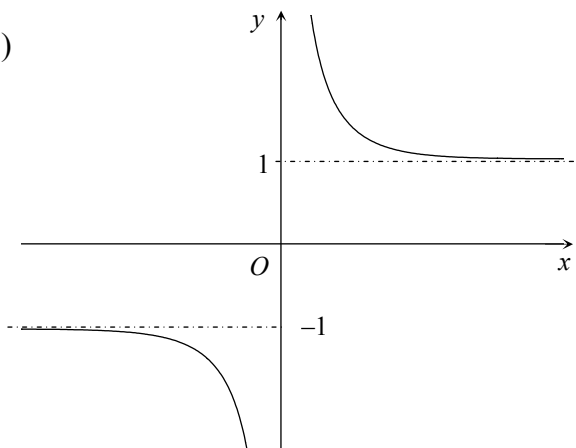

#### Exercise 6E

2.  $8 \cosh^4 x - 8 \cosh^2 x + 1$

#### Exercise 6F

1. (a)  $3 \sinh 3x$       (b)  $6 \sinh 3x \cosh 3x$       (c)  $2x \cosh x + x^2 \sinh x$   
 (d)  $\frac{2x \sinh 2x - \cosh 2x}{x^2}$       (e)  $\tanh x + x \operatorname{sech}^2 x$       (f)  $-\operatorname{sech} x \tanh x$   
 (g)  $-\operatorname{cosech} x \coth x$

**Exercise 6G**

1. (a)  $\frac{1}{3} \sinh 3x + c$  (b)  $\frac{1}{2} \left( x + \frac{1}{2} \sinh 2x \right) + c$   
 (c)  $\frac{1}{2} x \cosh 2x - \frac{1}{4} \sinh 2x + c$  (d)  $x - \tanh x$

**Exercise 6H**

3. (a)  $\ln \frac{1}{2} (3 + \sqrt{5})$  (b)  $\frac{1}{2} \ln 2$  (c)  $\ln 1.5$

**Exercise 6I**

1. (a)  $\frac{3}{9-x^2}$  (b)  $\frac{1}{\sqrt{9+x^2}}$  (c)  $\frac{1}{\sqrt{x^2-16}}$   
 (d)  $e^x \sinh^{-1} x + \frac{e^x}{\sqrt{1+x^2}}$  (e)  $\frac{2}{\sqrt{x^4-1}} - \frac{1}{x^2} \cosh^{-1} x^2$
2.  $\frac{2\sqrt{3}}{3} + \ln(2 + \sqrt{3})$

**Exercise 6J**

1. (a)  $\sinh^{-1} \frac{x}{3} + c$  (b)  $\cosh^{-1} \frac{x}{4} + c$  (c)  $\frac{1}{2} \sinh^{-1} \frac{2x}{5} + c$   
 (d)  $\frac{1}{3} \sinh^{-1} \frac{3x}{7} + c$  (e)  $\sinh^{-1} \frac{x+1}{2} + c$  (f)  $\cosh^{-1} \frac{x-2}{4} + c$   
 (g)  $\sinh^{-1}(x+2) + c$  (h)  $\cosh^{-1} \frac{x-1}{\sqrt{3}} + c$

**Exercise 6K**

1. (a)  $\ln 2$  (b)  $1, -\ln 7$  (c)  $\ln(\sqrt{2}-1), \ln(4+\sqrt{15})$   
 (d)  $\ln \frac{5+\sqrt{21}}{2}$  (e)  $0$

**Miscellaneous exercises 6**

1. (a)  $e^x$  (b) 1

2.  $\frac{1}{2} \ln 2$

3. (b)  $-\ln 2, \ln(2 + \sqrt{5})$

4. (b)  $\ln 4$

5. (c)  $-\frac{2}{3}, -\frac{4}{3}$

7. (b)(i)  $\frac{1}{2} \tanh^2 x$  (ii)  $\ln \cosh x - \frac{1}{2} \tanh^2 x$

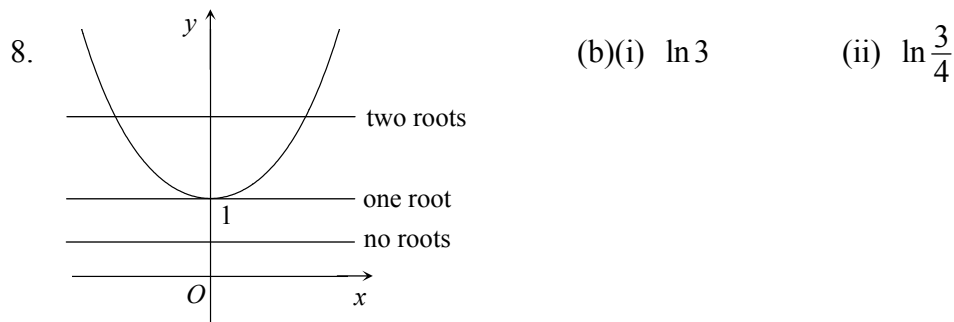

9. (a)  $x \geq 0$  (b)(ii)  $\sqrt{2} - \ln(\sqrt{2} + 1)$

10. (d)  $\frac{1}{8}(\ln 3)^2$

11. (c)(ii) 1.76

**Chapter 7****Miscellaneous exercises 7**

1. (b)(ii)  $s = \ln \cosh \theta$

2. (a)(i)  $\frac{97}{72}, \frac{65}{72}$  (b)  $\frac{6305}{5184}$

3. (a)(ii)  $1 - \tanh^2 \theta = \operatorname{sech}^2 \theta$

4. (b)  $k = 8\pi, \frac{20\sqrt{2}\pi}{3}$

5. (b)(i) 12 (ii)  $\frac{576}{5}\pi$

6. (a) 2